

**COTA**

# TRANSIT STOP DESIGN *guide*



# TABLE *of* CONTENTS

<b>SECTION 1</b>   <i>Introduction</i> .....	1
Purpose of Guidelines.....	2
Roles and Responsibilities.....	2
<b>SECTION 2</b>   <i>Development Review</i> .....	3
Design Review Services.....	4
Construction Coordination Services.....	5
<b>SECTION 3</b>   <i>Transit Stop Site Design</i> .....	6
Transit Bus Signage.....	7
ADA Landing Pad.....	8
COTA Freestanding Benches.....	11
Simme Seats.....	11
COTA Shelters.....	12
COTA Trash Receptacles.....	15
COTA Route & Informational Signs.....	16
Solar Lighting.....	16
Special Amenities.....	17
<b>SECTION 4</b>   <i>Streetscape Design</i> .....	18
Transit Stop Boarding Zone.....	19
Transit Spacing.....	21
Raingardens/Green Infrastructure.....	22
Micro-Mobility Hubs.....	23
Third Party Structures.....	25
Utilities.....	27

# TABLE *of* CONTENTS

- SECTION 5 | *Roadway Design*** .....29
  - Transit Vehicle Properties .....31
  - Roadway Dimensions .....32
  - Roadway Pavements .....32
  - Traffic Speeds and Volume .....33
  - Micro-Mobility Lanes .....37
  - Intersections & Roundabouts .....40
  - Mid-Block Transit Stops & Crosswalks .....50
  
- SECTION 6 | *Placemaking Design*** .....53
  - Specialty Stops .....54
  - Transit Stop Parklets .....55
  - Tactical Urbanism .....56
  - COTA Art Program .....56
  - Transit Amenity Contribution Program .....57
  
- APPENDIX**
  - COTA Taxing District .....59
  - Transit Sign Dimensions .....60
  - CBUS Circulator Sign Dimensions .....61
  - AirConnect Sign Dimensions .....62
  - CBUS Circulator/AirConnect Sign Dimensions .....63
  - COTA Freestanding Bench Dimensions .....64
  - Simme Seat Dimensions .....65
  - COTA 2' x 12' Shelter .....66
  - COTA 4' x 12' Shelter .....67
  - COTA 2' x 19' Shelter .....68
  - COTA Trash Receptacle .....69
  - Transit Guide Resources .....70



## SECTION 1 | *Introduction*

The Central Ohio Transit Authority (COTA) is the primary provider of transit service in the central Ohio region. COTA's service and taxing area consists of Franklin County and small portions of Delaware, Fairfield, Licking, and Union Counties. The areas served outside of Franklin County are within municipalities that are signatories to the COTA agreement.

COTA's public transit services are provided via two primary operations: fixed-route transit service and demand-responsive service. The demand-responsive service operations provide services to individuals and operate upon request. The backbone of COTA's system is fixed-route transit service. Service is provided on a repetitive, fixed schedule basis along a defined route, with vehicles stopping at over 3,200 designated stops. Since an individual's first impression when choosing to ride COTA is the transit stop, it is important that transit stops are identifiable, safe, accessible, and comfortable. Detailed locations such as Bus-Rapid-Transit (BRT), Terminals & Transits, and Park & Rides will not be discussed within this design guide; design requirements for these locations will require more coordination with COTA Staff and the Federal Transit Authority (FTA) guidelines. **See page 59** for a map depicting the current service locations of COTA's transit system.

COTA adheres to a policies of Title VI of the Civil Rights Act which ensures that no person is excluded, denied, or subjected to discrimination on the grounds of race, color, or national origin, with regards to both COTA services and facilities. All standards and recommendations put forth in this document should be applied in accordance with this policy.

# PURPOSE *of* GUIDELINES

The purpose of this guide is to provide designers, municipalities, and developers reliable design criteria that is consistent with COTA Standards, including regulations set forth by the Federal Transit Authority (FTA) and the Americans with Disabilities Act (ADA). COTA acknowledges that many stops were installed prior too many of these requirements being established.

**By collaborating on development projects early in the planning and design phases, it is COTA's goal to achieve the following objectives:**

- 1 Transit stops should be placed in convenient locations that do not compromise the safety of customers, pedestrians, vehicles, or other mobility modes of traffic (bicycles, scooters, etc.)
- 2 Transit stops should be spaced to maximize the efficient operation of transit service while not requiring riders to walk excessive distances (i.e. greater than one half mile) to the nearest transit stop.
- 3 Transit stops should be clearly and consistently identifiable with up-to-date information about service times and routes.
- 4 Transit stops should have appropriate amenities based on the usage of that stop and the surrounding land use.
- 5 Where feasible, transit stops should be accessible. Americans with Disabilities Act (ADA) considerations will be given top priority in the siting and design of new and existing transit stops.
- 6 Facilities surrounding transit stops such as roadways and pedestrian amenities should be transit-supportive and designed according to ADA requirements and appropriate traffic engineering practices (i.e. stopping sight distances, driver visibility).

# ROLE *and* RESPONSIBILITIES



In general, COTA is responsible for the siting and installation of new transit stops and determining appropriate stop amenities. COTA works with the appropriate municipal jurisdiction to obtain permits for the installation of any new transit stop to ensure that the stop meets all federal, state, and local regulations, including FTA and ADA standards.

It is the role of the municipalities and developers, with input from COTA, to provide infrastructure for transit users to access the transit stop service. Thus, when new development or redevelopment impacts a COTA transit stop, the ROW within the area of transit operation, or the immediate accessibility around the transit stop it is the developer's (or municipality's) responsibility to ensure that the stop can be adequately served by COTA's transit vehicles and easily accessed by transit customers. COTA encourages developers and municipalities to take existing and proposed transit stops into account, involving COTA during the initial planning and design phases and use the design guidelines provided to appropriately design the transit stops. Please note that it is the responsibility of the developer to ensure that all construction and design regulations are met, particularly when they are more stringent than COTA guidelines.



## SECTION 2 | *Development Review*

Because land use and development could affect COTA's existing and future transit service, COTA should be consulted with and involved in the planning and design phases of a project. COTA must be involved in the planning and design of the following activities: transit stop installation or upgrades, residential and commercial developments that will be served by transit vehicles. Through this early collaboration, transit service options can be identified and transit-oriented design features can be integrated into the development plans, thus minimizing conflicts later in the development process.

# DESIGN REVIEW SERVICES

COTA offers in-house plan reviews to municipalities, developers, and other in the development community. These reviews are designed to promote the inclusion of public transportation features in both urban and suburban developments. In some municipalities, City code may require a plan review by COTA and the implementation of the guidelines set forth in this manual. Whether required or not, COTA staff will analyze site plans and, when appropriate, suggest design options to make developments more easily served by transit.

*In order to review development plans and provide feedback, COTA requests the following items:*

## **A letter or e-mail identifying:**

- Municipality or developer requesting the review
- Information of appropriate contact person
- Project name and location
- Requested date for COTA Response

## **One paper copy and/or one electronic copy (PDF Format) of the development plan package including the following:**

- Title Sheet with project name and location
- Scale, North Arrow, and Date
- General notes
- Right-of-way (ROW) design and construction plans
- Streetscape/Landscape plans with utilities
- Maintenance-of-Traffic (MOT) plans & notes
- Plan profiles (if applicable)

Detailed plan information allows COTA to identify any needs and requirements related to transit service and stop locations. Site designs should accommodate COTA's transit vehicles and stop guidelines as much as possible including ADA accessibility to the transit stop locations.

If a site is not designed to accommodate COTA's transit vehicles and design guidelines, the transit mobility and/or pedestrians may be unable to access the stop. COTA reserves the right to withhold transit service until necessary changes are made. This includes ADA accessibility up to and at the transit stop as well as vehicle access requirements such as turning radii and pavement design.

# CONSTRUCTION *and* COORDINATION

When a construction project will effect existing COTA transit routes and stops, COTA Staff should be contacted as early as possible to ensure the effected transit routes and stops are still serviceable by COTA vehicles. COTA should be given at least two weeks advance notice of projects that will interfere with service so the proper reroutes and temporary stops can be identified and to ensure the public can be given sufficient notice of the service changes. To the extent possible, it is preferred that COTA's transit stops are allowed to remain operational throughout a construction phase and pedestrian access to the stops is maintained.

Construction projects that significantly alter an existing transit route or the surrounding land use of existing stops may elicit a re-evaluation of the current transit route and/or current location of the COTA transit stop. Route design and stop relocation will require early involvement from COTA staff to identify appropriate changes. Any development projects occurring outside of COTA's existing route requesting service, COTA must be involved in the planning phase to analyze the possibility of service for timing and route efficiency.







## SECTION 3 | *Transit Stop Site Design*

COTA strives to provide transit stops that are easy to identify and access, with convenient passenger amenities. COTA's transit system includes approximately **3,200 transit stops** of varying sizes with varying amenities. This chapter will identify design details for proper transit stop design as per the requirements of the 2010 ADA Standards for Accessible Design, dated September 15, 2010 by the Department of Justice. Additional material shall be referenced from Proposed Accessibility Guidelines for Pedestrian Facilities in the Public Right-of-Way, dated July 26, 2011 by the United States Access Board.

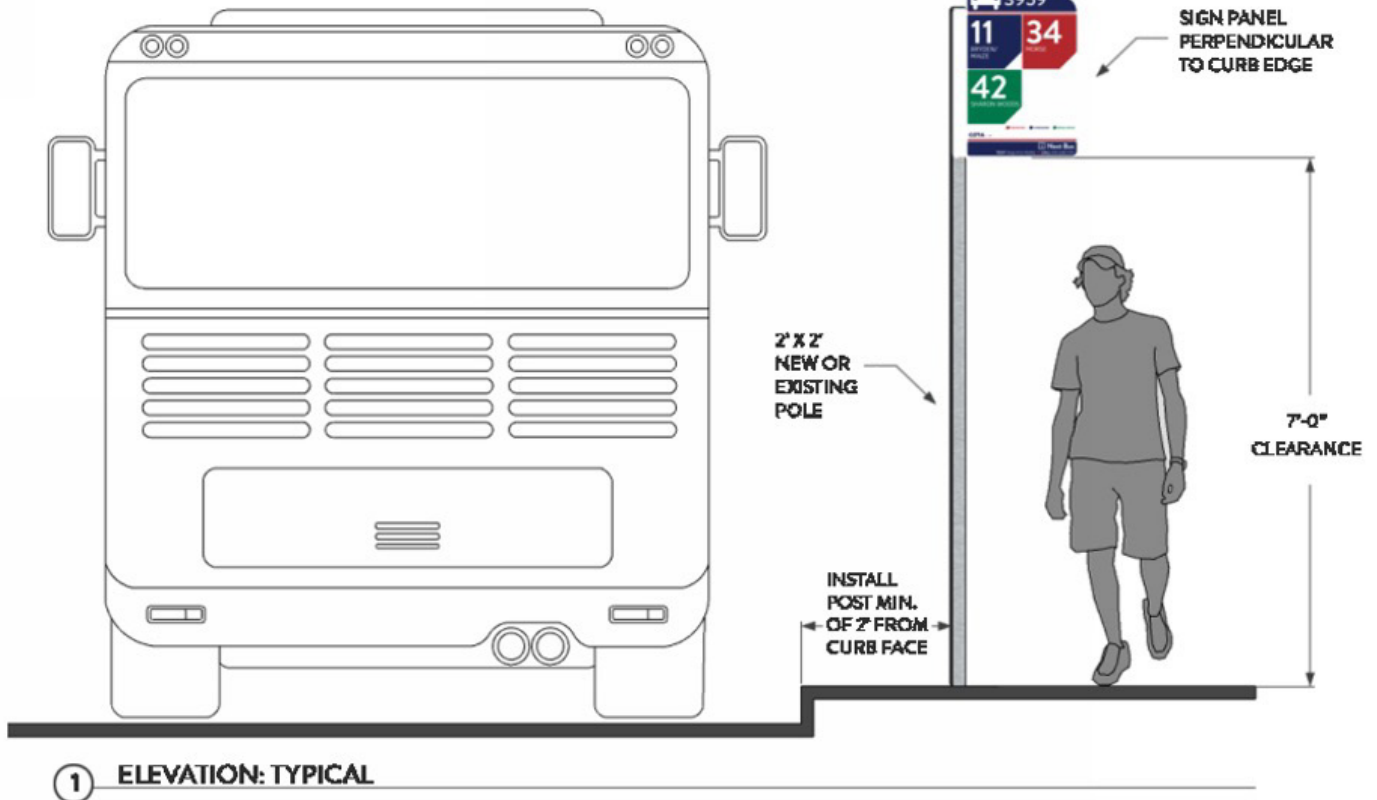
# TRANSIT BUS SIGNAGE

All COTA transit stops are designated with the placement of a COTA transit bus sign. The transit sign will consist of stop number located at the top of the sign and the transit routes that will service the stop. The transit bus sign is used as a marker to where passengers will egress and ingress the vehicle. Transit bus signage is to be mounted perpendicularly to the street at a distance of no less than 2ft from the curb. The sign may be placed farther from the edge of the curb but will required field investigation for site visibility. It can be bolted to a hard surface or driven into the ground. Per Section 403.5.1 of the 2010 ADA Standards, the clear width of a pedestrian accessible pathway may be reduced to 32 inches for a distance of 2ft in the direction of travel to account for an obstacle such as a transit sign. The transit bus sign shall be mounted no less than 7ft, in a vertical fashion, to pedestrian pathway surface. **See Figure 3-1 Sign Installation Standards** for additional information on the placement of a transit stop sign.

COTA also offers specific service routes located in the downtown region of Columbus that specifically supports downtown ridership, known as CBUS Circulator, and passengers wishing to be taken to the John Glenn International Airport, called the AirConnect. These special service indicators will be placed above the standard transit stop sign. **See pages 60-65** for specifications on the sign dimensions and design. Consult with COTA to determine if the transit stop in question supports a special service route.

**NOTES:**

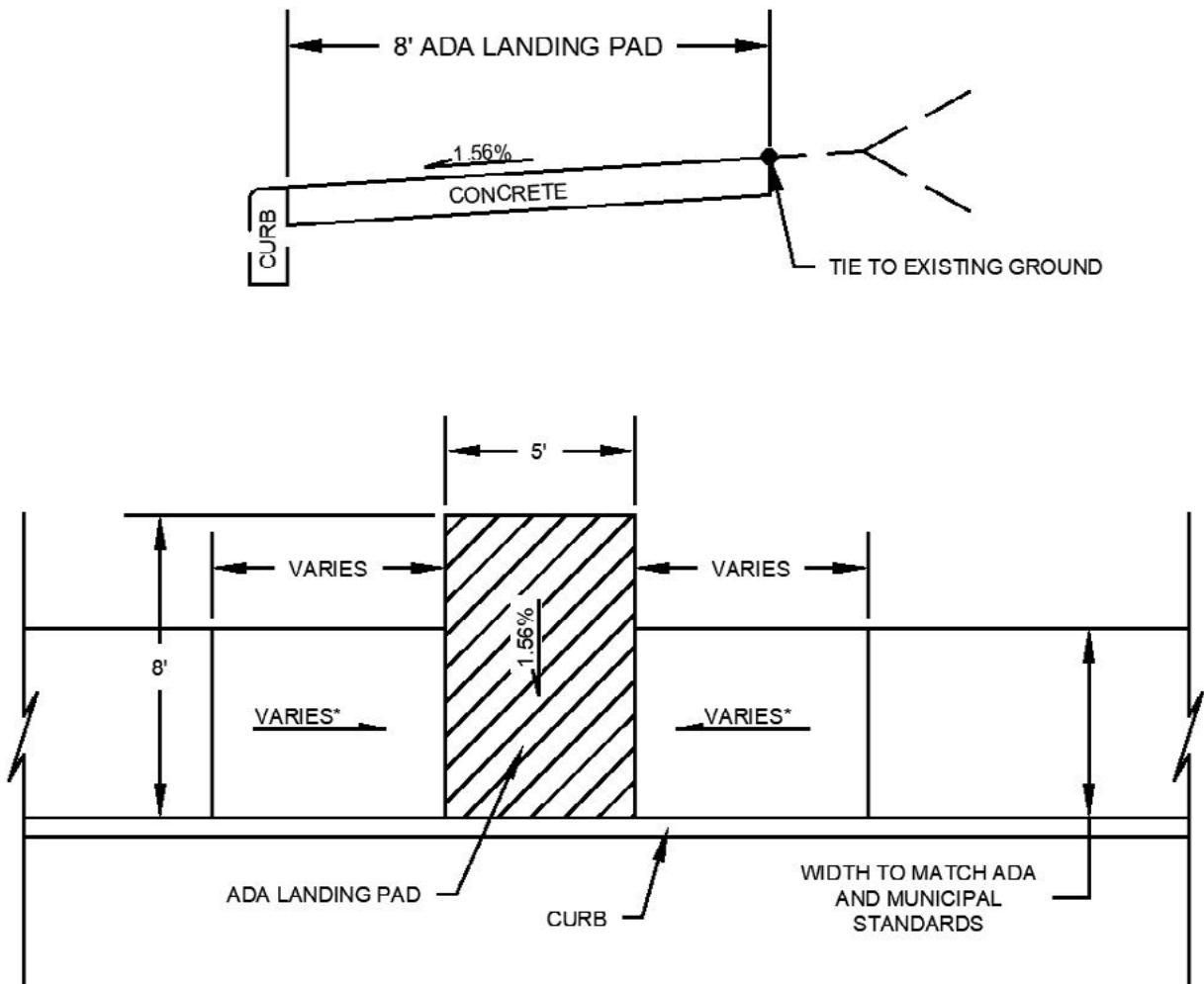
1. UNOBSTRUCTED SIGHT LINES SHOULD BE AVAILABLE BETWEEN STREET SIGN PANEL
2. SIGN POLE MUST BE PLACED IN A LOCATION WHERE IT WILL NOT INTERFERE WITH A MINIMUM CLEAR PATH WIDTH OF 32 INCHES.



**Figure 3-1** Sign Installation Standards

# ADA LANDING PAD

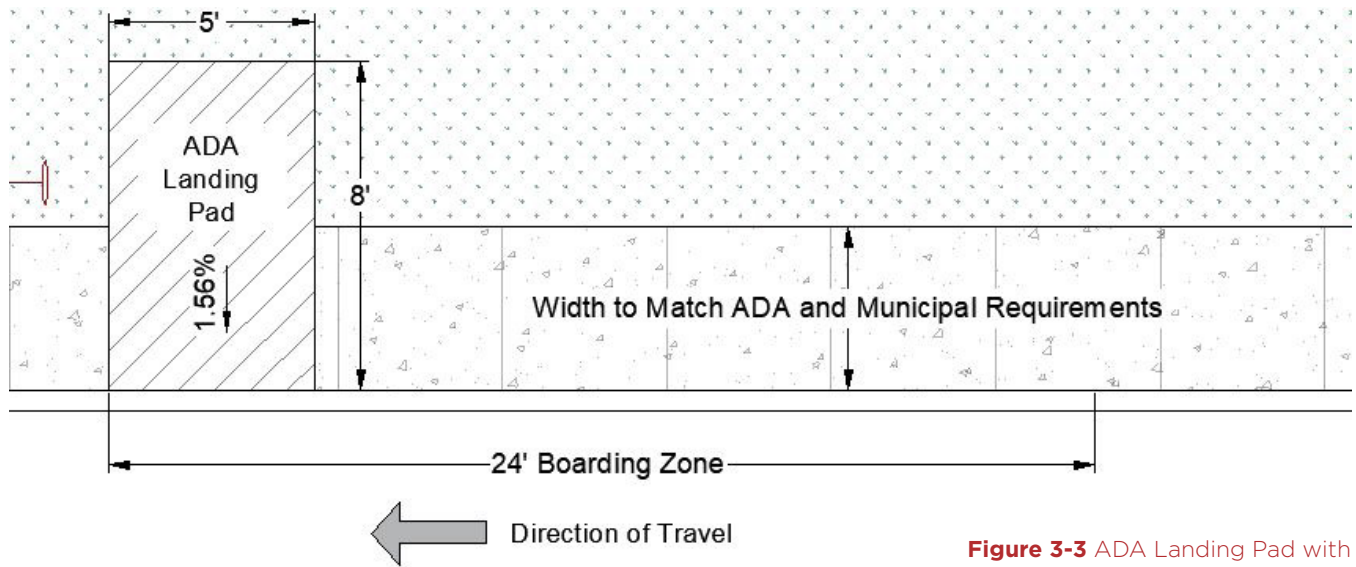
COTA strives to provide easy access on and off COTA vehicles at each transit stop location for all individuals. Section 35.151 New construction and alterations of the 2010 ADA Standards state that any transit stop site should be made readily accessible and usable by individuals with disabilities. To fulfill these needs, Section 810.2 Bus Boarding and Alighting Areas of the 2010 ADA Standards require an area free of any obstructions and have dimensions of no less than 5.0ft in width parallel to the curb and 8.0ft in depth away from the curb with a slope be no greater than 1.56% in any direction. This area will be called the ADA landing pad. **NOTE**, the location of the of the pedestrian path comprised of the ADA landing pad will now be required to adhere to a slope in any direction no greater than 1.56%. As such, the areas of sidewalk both downstream and upstream of the ADA landing pad may be required to slope towards the pad. It is recommended this slope not exceed + 5%, however the maximum slope shall not exceed + 8%. Consult your local municipality for maximum longitudinal slopes standards. See Appendix B for links to some local municipality guidelines. **See Figure 3-2 ADA Landing Pad** for a visual representation.



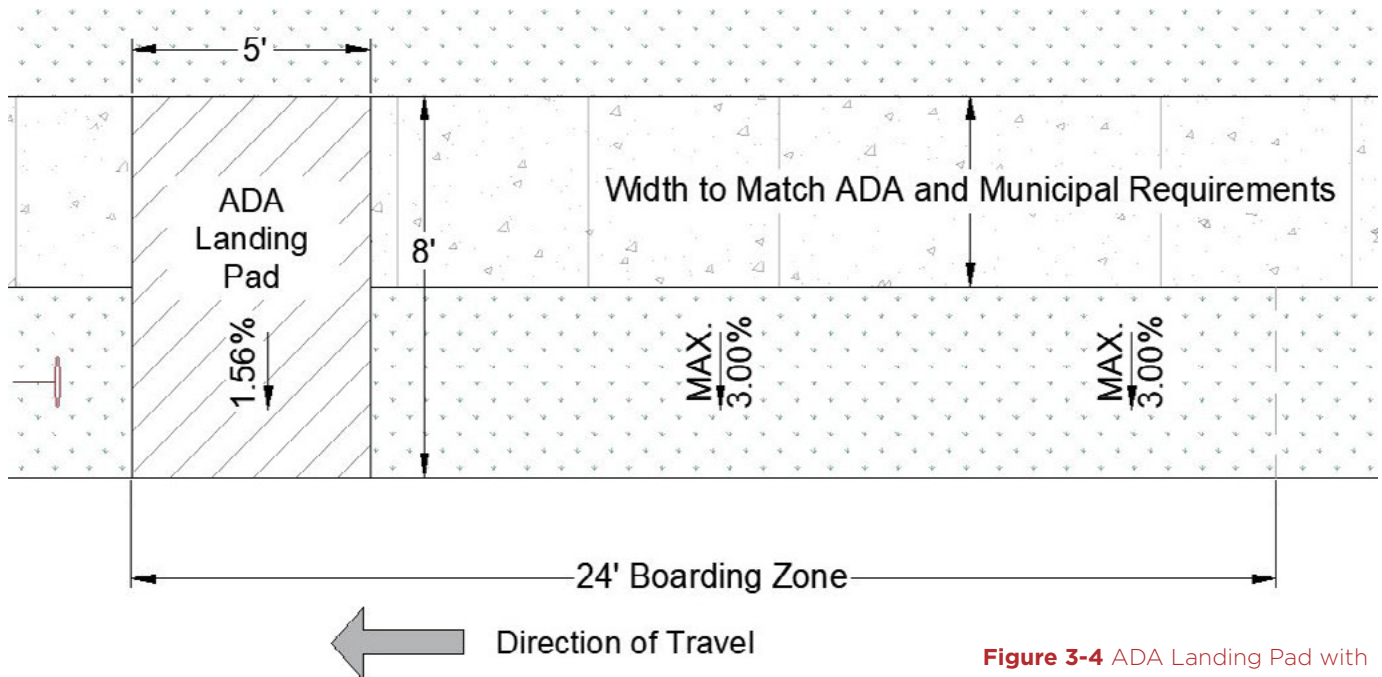
**Figure 3-2** ADA Landing Pad

COTA recommends the use of a 4 inch thick concrete to construct these ADA landing pads, however, recognizes that aesthetic architecture and/or local municipalities may prefer other materials. These materials should meet the definition found in Section 302.1 of the 2010 ADA Standards. Reference your local municipality or Right-of-Way Jurisdiction guidelines for material and detail design of the pad. See Appendix B for links to local municipality's guidelines. The ADA pad should be placed downstream of the transit bus sign as the sign designates where the front door opens. Section 206.2.1 Arrival Points of the 2010 ADA Standards require the ADA landing pad have at least one accessible route to the pedestrian pathway or sidewalk in the area. This accessible route should comply with Section 403 Walking surfaces of the 2010 ADA Standards.

The ADA landing pad may be a part of the pedestrian pathway. This methodology, allows for the reduction in material and Right-of-Way usage. **Figures 3-3 ADA Landing Pad with Pedestrian Path Adjacent to Curb** and **3-4 ADA Landing Pad with Pedestrian Path Setback from Curb** are examples of ADA landing pads engaged in the pedestrian pathway. The local municipality or Right-of-Way Jusisdiction will provide recommendations for the width of the sidewalk based on the proximity to the edge of the curb.

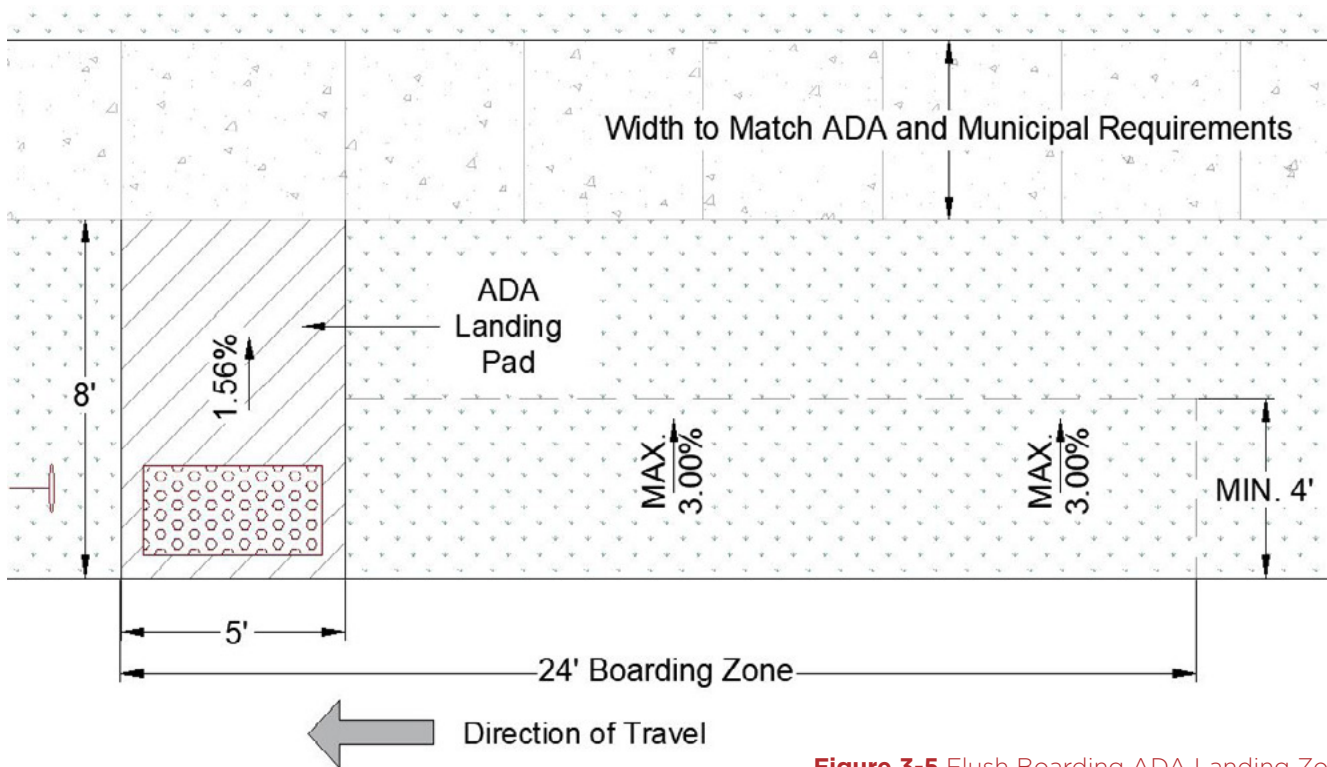


**Figure 3-3** ADA Landing Pad with Pedestrian Path Adjacent to Curb



**Figure 3-4** ADA Landing Pad with Pedestrian Path Setback from Curb

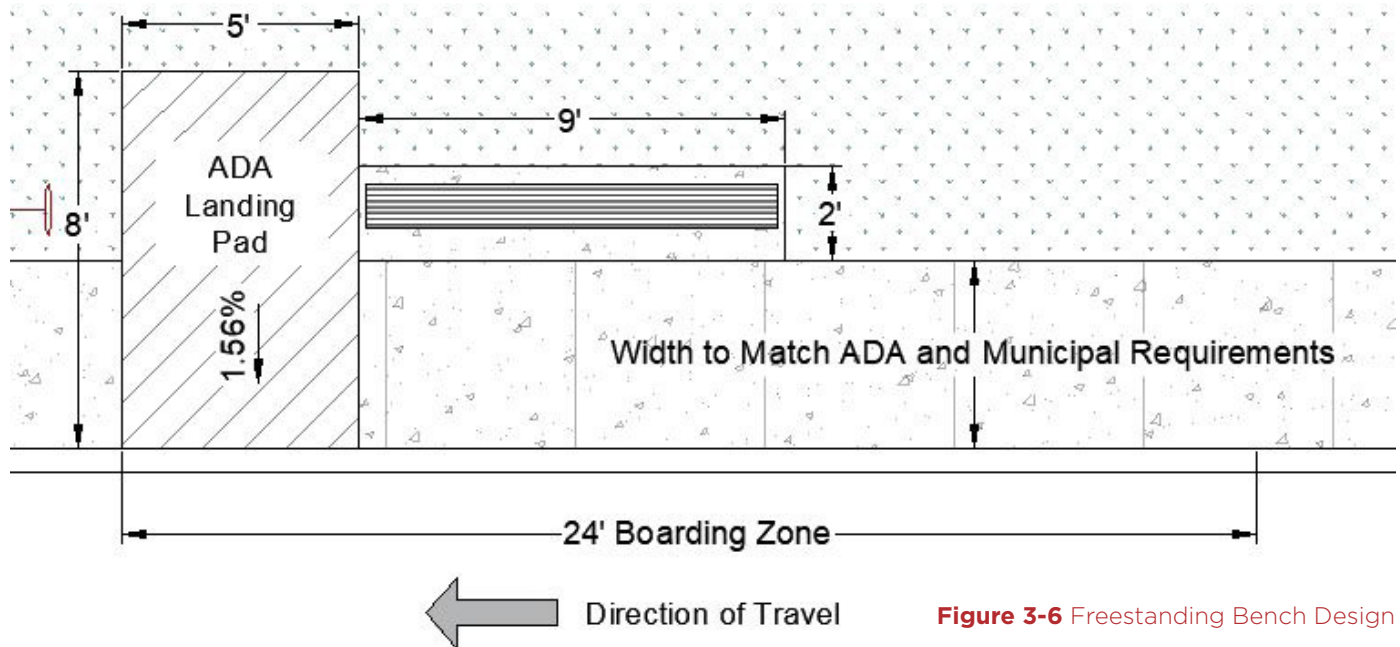
COTA acknowledges that some roadways are not equipped with a curb and gutter drainage design, but rather a gravel shoulder that slopes away from the roadway and into a grass ditch way. In such scenarios, where a curb does not exist, it is recommended the accessible path be a minimum of 5ft from edge of the roadway shoulder. The ADA landing pad shall be made flush with the edge of pavement of the roadway, having a slope no greater than 1.56% in any direction, and connected to the accessible path in the area with a recommended longitudinal slope of 5% and maximum slope of 8%. Per the Proposed Public Rights-of-Accessibility Guidelines Section R305.2.7 Boarding and Alighting Areas, boarding zones that are flush with the street cross-sections shall be guarded with a Detectable Warning Surface. **See Figure 3-5 Flush Boarding ADA Landing Zone** for an example. Detectable Warning Pads shall conform to R304.1 General and all of its constituents.



**Figure 3-5** Flush Boarding ADA Landing Zone

# COTA FREESTANDING BENCHES

COTA recognizes that customers using the transit system may experience a waiting time while at a transit stop. To improve the customer experience, COTA offers the placement of a freestanding bench for locations with a minimum of 25 passenger boardings per day and/or locations with surrounding area needs deemed appropriate. The standard freestanding bench is approximately 95.25 inches in length by 19 inches in height by 12.5 inches in depth. **See page 64** for a detail of the standard freestanding bench. The free standing bench shall be placed a minimum of 5ft from the edge of curb or further as not to encroach in the pedestrian pathway. If needed the freestanding benches should be mounted onto a concrete pad 4 inches thick of dimensions measuring no less than 9ft in width by 2ft in depth for bolting purposes.



**Figure 3-6** Freestanding Bench Design

The COTA Freestanding bench shall not be placed within the designated ADA landing pad location and not after the Transit Bus Sign, where possible. This helps reduce the required space needed for the overall transit stop site. Please coordinate with the COTA for site restricted designs.

# SIMME SEATS

The Simme Seat is a prefabricated seating option that should be used in locations with very low ridership and/or very limited Right-of-Way. The Simme Seat shall not encroach in the ADA landing pad and shall be placed a minimum of 5ft from the edge of curb or further as not to encroach in the pedestrian pathway. **See page 65** for details of the Simme Seat dimensions and installation methods provided by the manufacturer.

# COTA SHELTERS

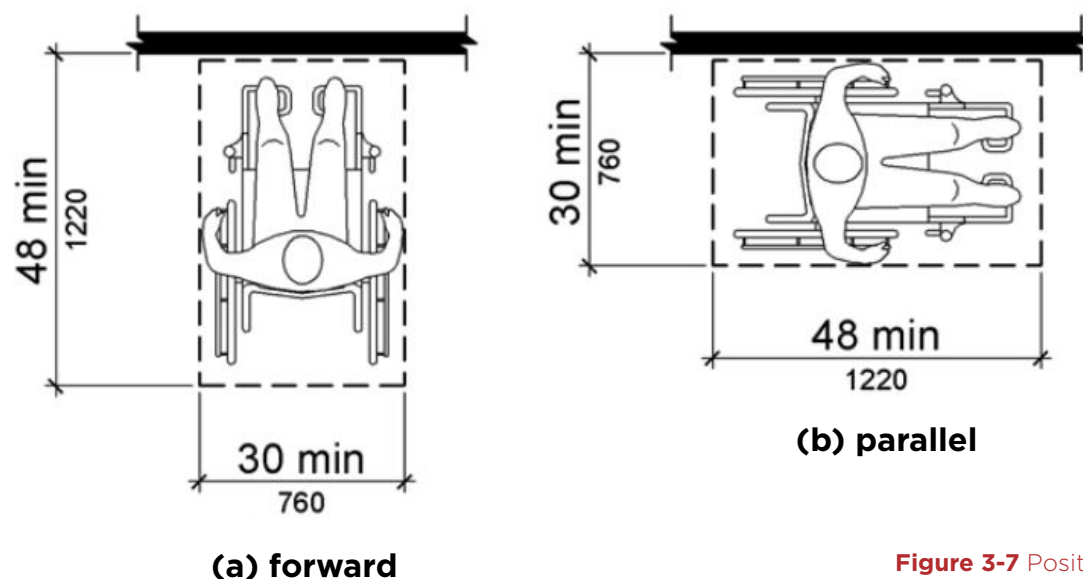
COTA strives to provide comfortable waiting areas for all passengers. Locations with 35 or more passenger boardings will be considered for shelters; however, there are additional criteria to be considered that would also warrant the placement of a shelter:

- Proximity to medical facilities, senior housing, and/or assisted living
- Areas with adequate Sight Visibility (Reference the local municipality, Right-of-Way Jurisdiction, or Ohio Department of Transportation for Sight Distance requirements at Intersections and Driveways and **Section 5: Roadway Design**)
- Major transfers between transit routes
- Privately funded shelters (See **Section 6: Placemaking** for additional information)

COTA currently offers three standard shelter sizes to be considered during the transit stop design. All COTA shelters shall be placed a minimum of 5ft from the edge of curb or further as not to encroach in the pedestrian pathway. If possible a minimum 4ft wide pedestrian pathway should be allotted behind the shelter specifically for non-passenger use. The three available sizes are as follows:

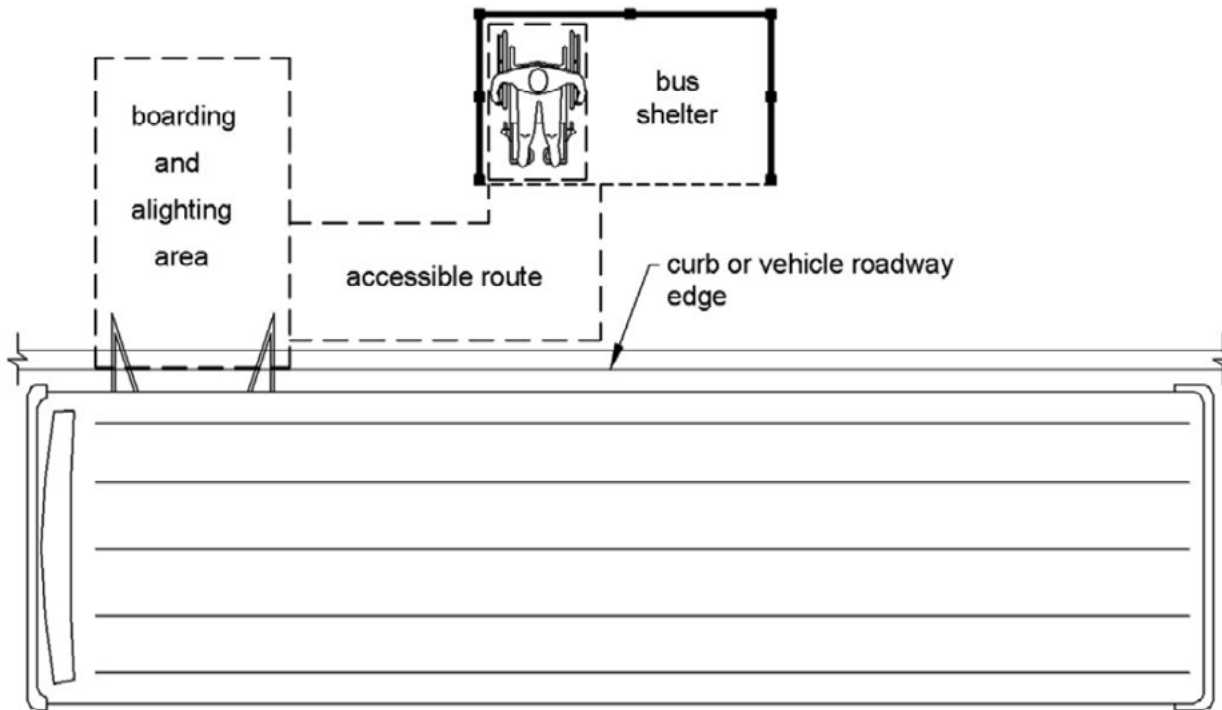
- **2' x 12' Shelter:** Used when the Right-of-Way and the Pedestrian pathway is restricted in depth.
- **2' x 19' Shelter:** Used in areas with high ridership, typically transfer points, and/or Right-of-Way depth is restricted.
- **4' x 12' Shelter:** Recommended shelter for new design and major streetscape upgrades where ample Right-of-Way is available.

It is recommended the shelter be placed on a flat 6inch thick 3000psi concrete pad with a surface area 6inches wider on all sides, if a flat stable surface does not already exist. This is to provide an adequate surface to bolt the shelter. Section 305.5 of the 2010 ADA Standard requires a minimum clear floor space of 2.5ft by 4.0ft within the shelter space. The shelters are designed for a forward approach to the clear floor space. **See Figure 3-7 Position of Clear Floor Space** for a visual representation. Specifications and details of the available standard shelters can be found on **pages 66-68** in the appendix of the design guide.



**Figure 3-7** Position of Clear Floor Space  
(From 2010 D.O.J. ADA Guidelines)

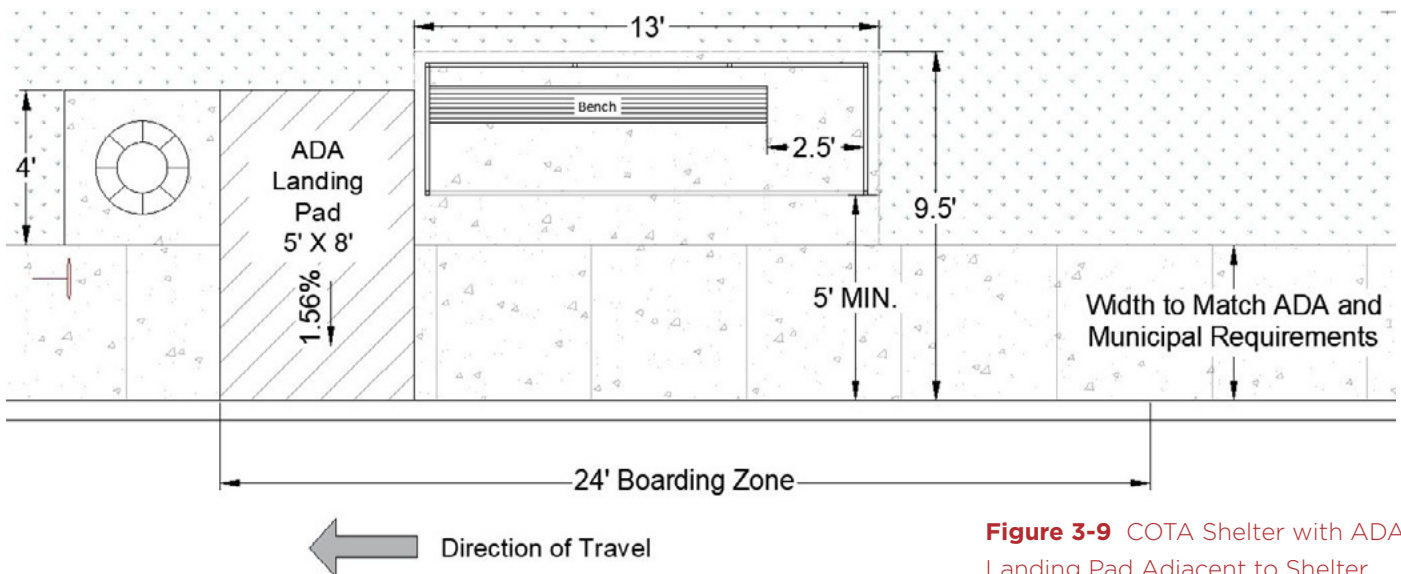
The COTA shelter shall have an accessible route connecting it to the ADA landing pad in accordance to Section 403.5.2 Clear Width at Turn and Section 302 Floor or Ground Surfaces of the 2010 ADA Standards. The accessible route is required to be free of amenities and other items that will hinder mobility through the route. **See Figure 3-8 COTA Shelter with Accessible Route.**



**Figure 3-8** COTA Shelter with Accessible Route  
(From 2010 D.O.J. ADA Guidelines)

Additional pedestrian accessible routes should also be provided to a pedestrian pathway. **Figures 3-9 through 3-12** are examples of shelter placements in coordination with the ADA landing pad and the pedestrian pathway. **NOTE**, the examples are based on the standard 4' x 12' Shelter design; design requirements for the ADA landing pad, trash receptacle, shelter, offset from curb, and sidewalk dimensions shall be maintained equally for all shelter sizes.

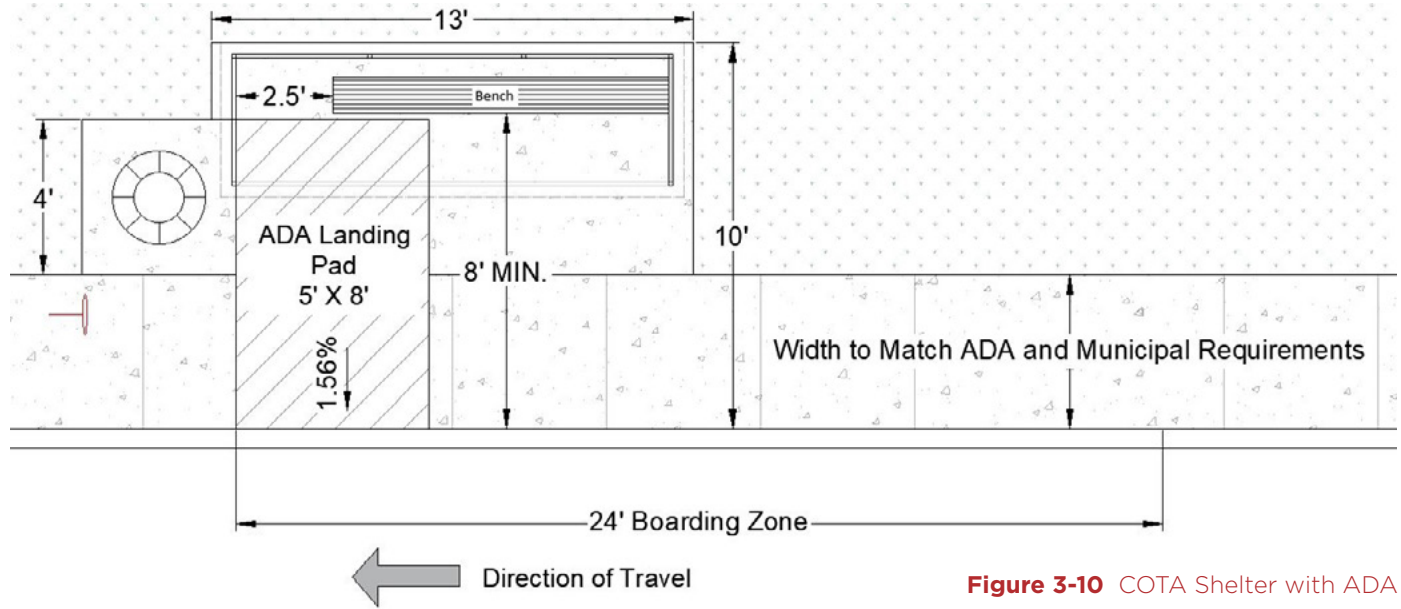
A design scenario that could incorporate the layout shown in **Figure 3-9 COTA Shelter with ADA Landing Pad Adjacent to Shelter** may have Right-of-Way restrictions, forcing the shelter to the back of the Right-of-Way.



**Figure 3-9** COTA Shelter with ADA Landing Pad Adjacent to Shelter

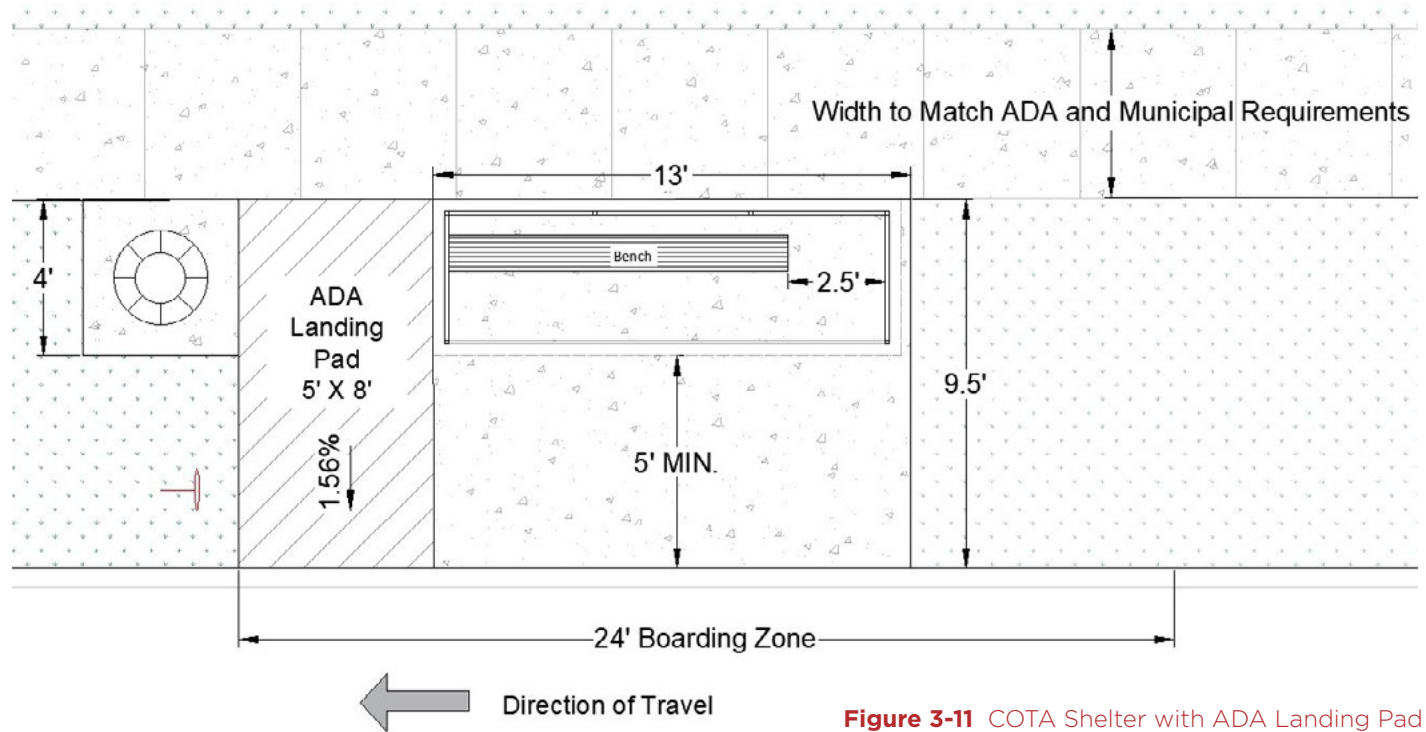


A design scenario that could incorporate the layout shown in **Figure 3-10 COTA Shelter with ADA Landing Pad in Front of Shelter** may have Right-of-Way restrictions and tight streetscape space. This design shows the landing pad within the shelter area, while unobstructed.



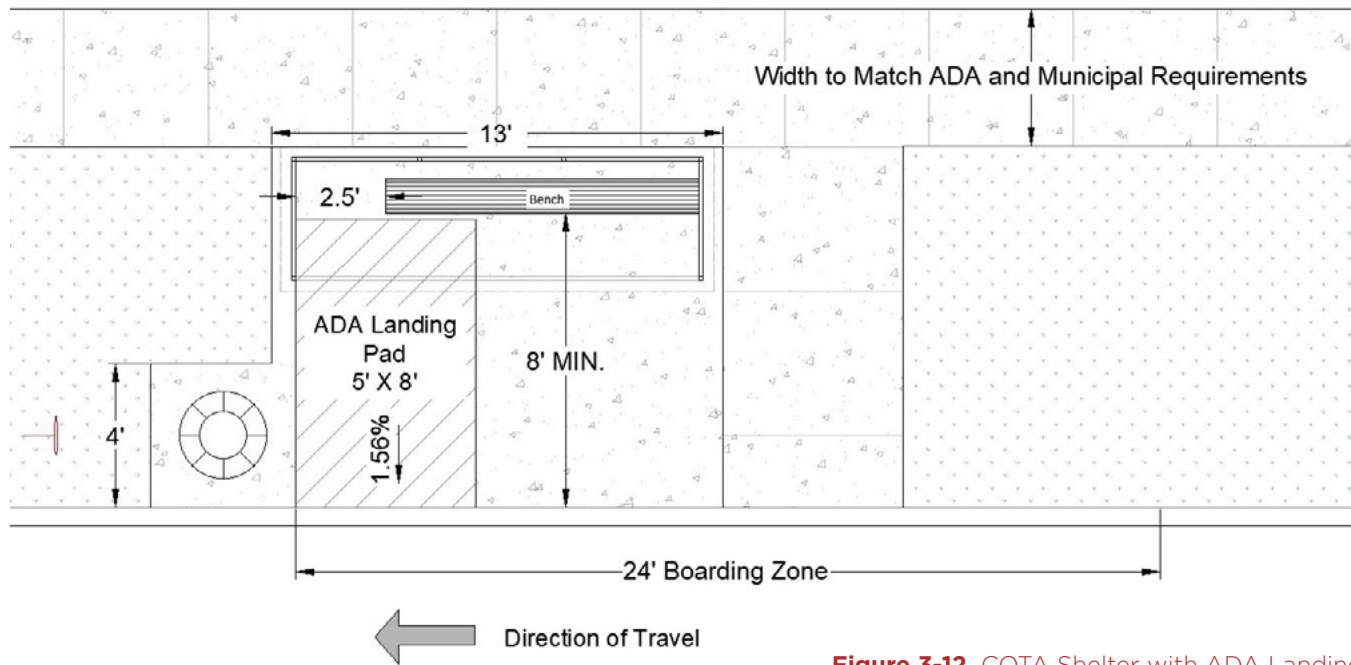
**Figure 3-10** COTA Shelter with ADA Landing Pad in Front of Shelter

A design scenario that could incorporate the layout shown in **Figure 3-11 COTA Shelter with ADA Landing Pad Adjacent to Shelter and Sidewalk to the Rear** may have adequate Right-of-Way space to provide a pedestrian pathway behind the transit stop.



**Figure 3-11** COTA Shelter with ADA Landing Pad Adjacent to Shelter and Sidewalk to the Rear

A design scenario that could incorporate the layout shown in **Figure 3-12 COTA Shelter with ADA Landing Pad in Front of Shelter and Sidewalk to Rear** may have adequate Right-of-Way space but limited streetscape space, potentially do to utilities, etc.



**Figure 3-12** COTA Shelter with ADA Landing Pad in Front of Shelter and Sidewalk to Rear

## COTA TRASH RECEPTACLES

COTA has made it an initiative to promote clean streets and a clean environment. COTA will conduct an evaluation of a transit stop site to determine if a COTA trash receptacle is required. Transit stops consisting of a COTA Shelter will always include a COTA trash receptacle. The COTA trash receptacle can be placed a minimum of 24in from edge of trash receptacle to the edge of curb or in location that does not hinder the pedestrian route or any accessible route into the transit stop site. The trash receptacle should be placed on a hard surface complying with Section 302.1 of the 2010 ADA Standards. If the location does not consist of an existing flat, hard surface, COTA recommends a 4inch thick, 3000psi concrete pad with an area of 48inches by 48inches, for bolting purposes. **See page 69** for details on the COTA trash receptacle.

# COTA ROUTE & INFORMATIONAL SIGNS

COTA Route and Informational Signs will be found on one side of transit shelter or attached the transit stop pole. Neither of these options will take up additional space at the transit stop. The most common route and informational signs are laminated paper copies of times and routes servicing a given location. Digital devices are also available in limited quantities. **See Figure 3-13 Route & Informational Signs** for more information.

## SOLAR LIGHTING

COTA recognizes that even in some urban environments, public lighting or street lighting may not be available. Ideally, the transit stop site should be located within 50ft of an overhead light source and design methods should implement lighting within the streetscape. Lighting at the transit stop should be 2.0 foot-candles at design with a minimum of 15 foot-candles if the design parameter cannot be met. COTA recommends a lighting study of the proposed transit stop location prior to design to ensure light requirements are met.

COTA reserves the right to introduce additional lighting in conjunction to the streetscape lighting, if deemed necessary, but design parameters must be adhered to as top priority. COTA offers two solar lighting options. The simplest option is a pole mounted light that is placed above the COTA transit stop sign. The pole mount is extended above the sign to illuminate the both the sign and the surrounding area. In the event the transit stop has a shelter, a light can be placed in the shelter and the solar panel mounted above the roof. Neither of these options take up additional space within the transit stop.



i  
TRANSFER  
Zone 1

You are in transfer Zone 1.  
 You may transfer to the lines below in this zone:

ROUTE NUMBER / NAME	DIRECTION	TRANSFER STOP
1 KENNY / LIVINGSTON	Southbound	1C
1 KENNY / LIVINGSTON	Northwest	1D
2 E MAIN / N HIGH	Southbound	1C
2 E MAIN / N HIGH	Northbound	1D
2L N HIGH / POLARIS PKWY	Northbound	1D
3 NORTHWEST / HARRISBURG	Southwest	1C
3 NORTHWEST / HARRISBURG	Northwest	1A
4 INDIANOLA / LOCKBOURNE	Southbound	1A
4 INDIANOLA / LOCKBOURNE	Northbound	1C
5 W 5TH / REFUGEE	Westbound	1E
5 W 5TH / REFUGEE	Southbound	1A
6 CLEVELAND / SULLIVANT	Westbound	1C
6 CLEVELAND / SULLIVANT	Northbound	1D
7 M TVERNON	Northwest	1C
8 KARL/S HIGH	Northbound	1A
8 KARL/S HIGH	Southbound	1C
9 W MOUND / BRETNELL	Westbound	1C
9 W MOUND / BRETNELL	Northwest	1A
11 BRYDEN / MAIZE	Southbound	1A
11 BRYDEN / MAIZE	Northbound	1C

Zone 1 transfer stop locations:

1A W Spring St & N Front St	stop #3142	6 MINUTES
1B N High St & E Long St	stop #5910	2 MINUTES
1C N High St & W Long St	stop #4101	<span style="color: red;">◀ You Are Here</span>
1D E Long St & N High St	stop #4157	2 MINUTES
1E N Front St & W Long St	stop #7338	4 MINUTES

COTA.com

Figure 3-13 Route & Informational Signs

# SPECIAL AMENITIES

In select instances, additional amenities may be placed on site to enhance the customer experience.

**These amenities can include:**

- Powered lighting
- Powered digital mapping and wayfinding signs
- Powered heating systems
- Powered security system

The physical nature of powered amenities will require additional coordination with the local municipality or Right-of-Way jurisdiction. An evaluation of a site may require additional engineering design, permitting, inspection and specialized construction efforts.

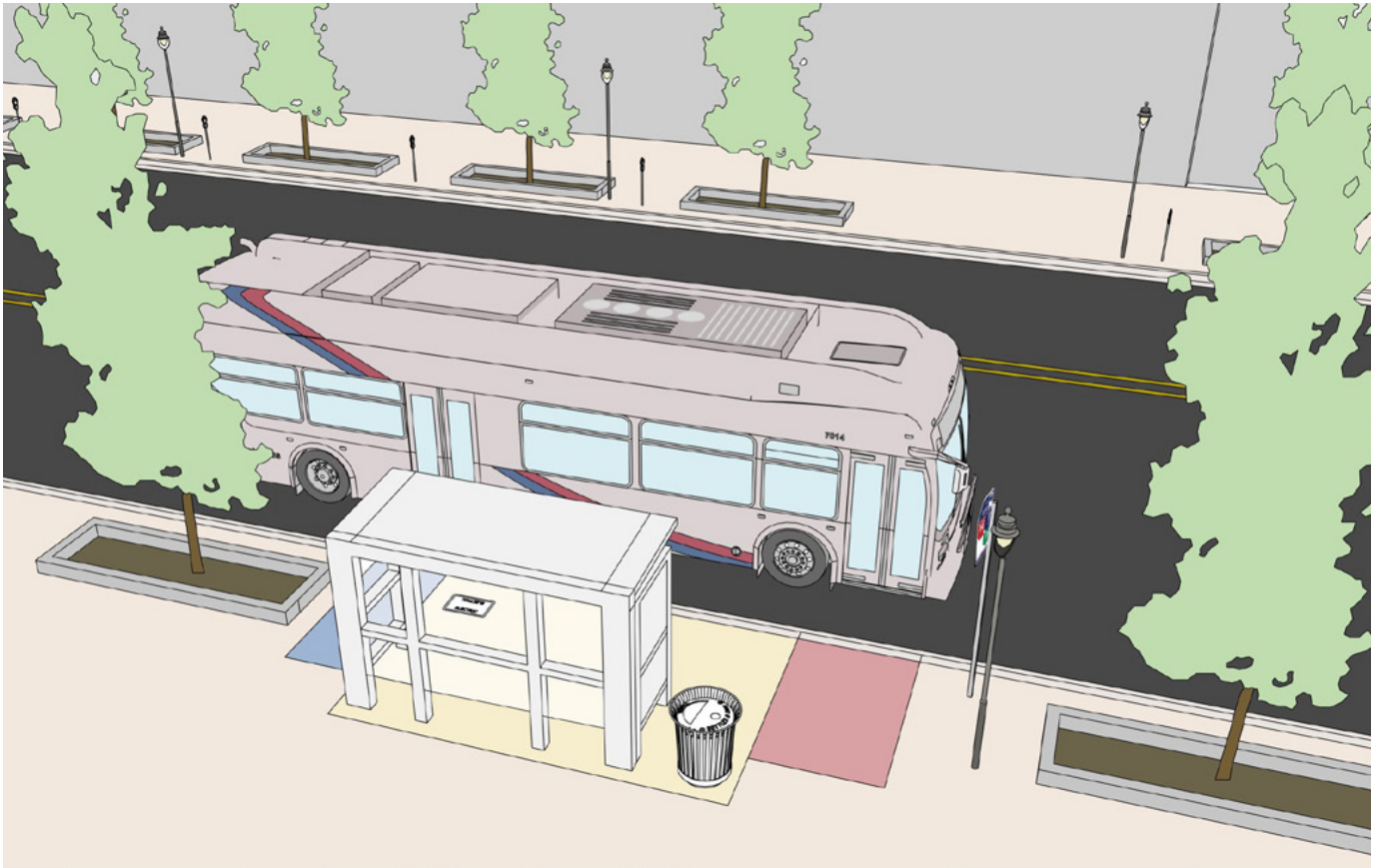


## SECTION 4 | *Streetscape Design*

This chapter provides guidelines to ensure a safe and ADA compliant transit stop is implemented into a city streetscape design. A public streetscape can consist of a variety of items that can promote or inhibit pedestrian use. These items can include anything from pedestrian pathways or sidewalks, raingardens and tree grates, micro-mobility, advertisement structures, to public utilities. **NOTE**, please consult the local municipalities design standards for placement and interaction of public utilities.

# TRANSIT STOP BOARDING ZONE

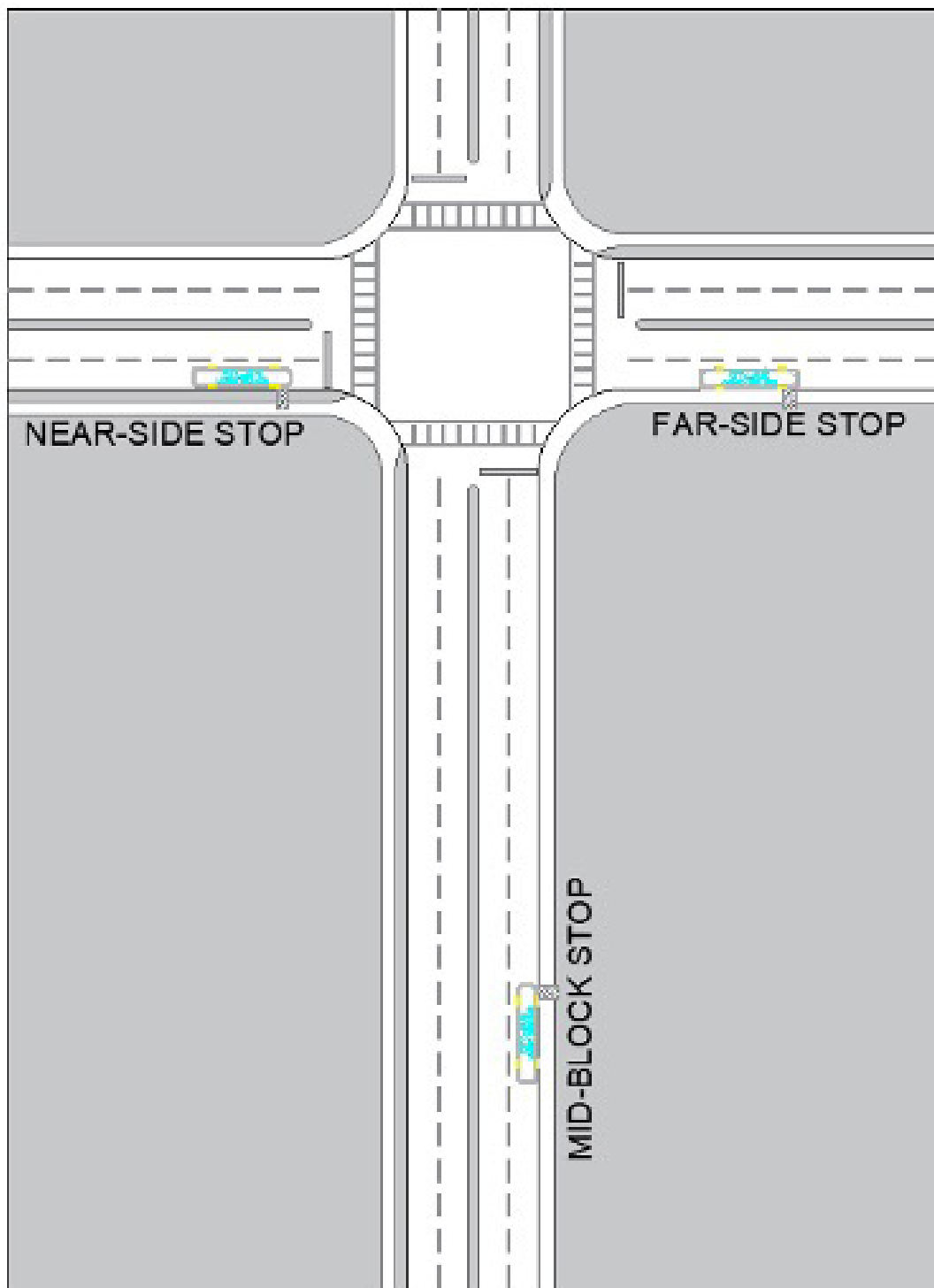
COTA's vehicles are designed for ADA front entry. For this reason the ADA landing pad, transit stop signage, and other amenities mentioned in **Section 3 Transit Stop Site Design** are to be designed for front ingress & egress of ADA persons. However, when exiting the vehicle, all other passengers have the option to utilize the front or rear door at the stop location. This area is known as transit stop boarding zone. COTA's standard fleet consists of 35ft and 40ft vehicles. **See Figure 4-1 Boarding Zone Parameters.**



**Figure 4-1** Boarding Zone Parameters

**Shown in Figure 4-1 Boarding Zone Parameters**, the shaded zone in **RED** shall meet the parameters required for the ADA landing pad. The zone in **BLUE** should be a minimum of 4ft in width, free of any obstructions, and have surface that is firm, stable, and slip resistant per Section 302.1. The zone in **GOLD** should be reserved for benches or shelters and meet the parameters listed in **Section 3 Transit Stop Site Design**. The remaining area is called the clear zone and may be of being used for other items within the streetscape design. The size and number of vehicles located on a route should be coordinated with COTA prior to design to ensure adequate utilization of all streetscape space in the area. If a transit stop services multiple routes, only one **GOLD** zone is necessary, however, the placement of additional **RED** and **BLUE** zones will be required. Multiple transit routes and/or high ridership may constitute the use of a 2'x19' shelter. In this scenario the **GOLD** and **BLUE** zones may overlap. Please consult with COTA services for route information.

Boarding zones are typically placed in one of three idealized locations within the streetscape area: Far-side (located immediately after an intersection); Near-side (located immediately before an intersection); and Mid-block (located between intersections). **Figure 4-2 Idealized Transit Stop Boarding Zone** provides an overview with respect to the intersection(s). COTA prefers to place stops Near- and Far-side to provide better access to signalized crosswalks for passengers, however, true stop placements will be based upon the intersection design, parking restrictions, bike lanes, speed limits, the number of lanes, and pedestrian access routes to name a few. For information based on the interaction of the transit stop and any roadway design parameters, please reference **Section 5: Roadway Design**.



**Figure 4-2** Idealized Transit Stop Boarding Zone

# TRANSIT SPACING

The implementation of transit stops along a streetscape first requires a focus on optimizing safety followed by a fine balance between the time efficiency of the transit service and customer convenience. When specifically looking at stop spacing and placement, the efficiency of a transit service route is based upon the dwell time or rate at which it takes a vehicle to brake, stop, board and allot passengers, and accelerate to the next stop. If transit stops are spaced close together, the sum of these dwell periods begin to increase the time a vehicle can get through its route. Whereas, further spaced stops allow for the opportunity to reach a constant velocity in route, thusly improving its rate through a route.

To account for human behavior, transit stop placement must consider each site with context sensitivity. Designers and planners should consider the following parameters when placing a transit stop to optimize safety first, then convenience and efficiency:

- Begin with the recommended spacing guidelines from **Chart 4.1 Idealized Transit Spacing Guidelines**
- If a marked crosswalk or stop controlled intersection is within a few hundred feet, consider shifting the stop as close as possible to the crosswalk/stop control – preferably on the far side of the crosswalk to encourage riders to cross behind the vehicle
- Consider adding stops based on population densities and/or special populations (people with mobility limitations as an example)
- Consider trip-generating destinations- employment centers, grocery markets, medical facilities, and/or educational facilities – if these exist but no marked crosswalks or stop controlled intersections are nearby, work with the local municipality to consider adding one.
- Pedestrian accessibility and safety- lack of sidewalk infrastructure and crosswalks, and/or poor lighting – but can be improvements included as part of the bus stop placement
- Additional considerations can be based upon roadway limitations and are discussed in **Section 5 Roadway Design**.

As a typical overview of the transit stop spacing, COTA has established Table 4.1 Idealized Transit Stop Spacing Guidelines based on the Central Ohio Region along with NACTO design information for Transit Route Types.

**See page 70** for a link to the NACTO Transit Route Types.

DENSITY/LAND USE	SPACING RANGE
High density residential, Central Business District, commercial (>20 persons/acre)	<b>500-700 ft.</b>
Fully developed residential area (10 - 20 persons/acre)	<b>700-850 ft.</b>
Low density residential (3 - 10 persons/acre)	<b>850-1200 ft.</b>
Rural (or Express Transit Service) (0 - 3 persons/acre)	<b>500-700 ft.</b>

**Chart 4.1** Idealized Transit Spacing Guidelines



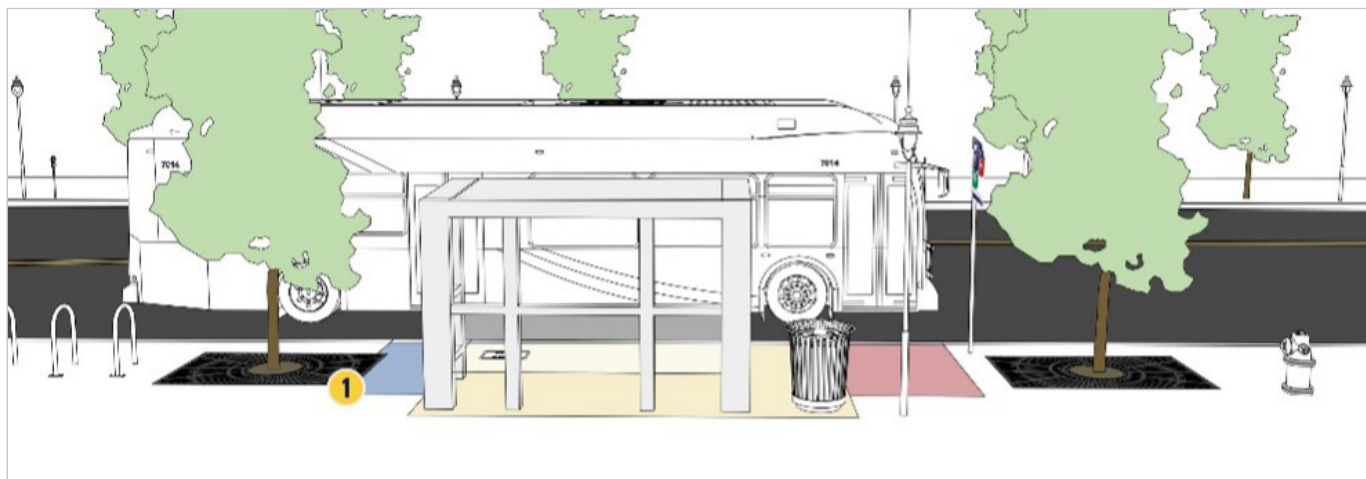
# RAINGARDENS/GREEN INFRASTRUCTURE

Raingardens/Green Infrastructure provide a means of water quality, habitat, and are aesthetically pleasing. They can include small trees, bushes & shrubs, grasses, and/or flowers. While raingardens can add life to a streetscape, they can also act as an obstacle to pedestrians along with passengers boarding and alighting the transit system. When designing a streetscape with raingardens or other green infrastructure, they may be placed in the clear zone if necessary, but they should be placed in a manner that allows the transit operator to safely maneuver the vehicle into the boarding zone. A minimum of 4ft of clear space width is required in the **BLUE** zone, shown at bullet 1 of **Figure 4-3 Raingardens in Proximity to the Boarding Zone**. Bullet 2 is shown as a 4'x12' standard shelter in this example. The placement and spacing of raingardens should also take into consideration the number of transit routes serving a stop.



**Figure 4-3** Raingardens in Proximity to the Boarding Zone

Some raingardens may consist of an ADA compliant tree grate system that provides a means to drain water to the tree roots while also providing a hard surface meeting Section 302 of the 2010 ADA Standards. It should be noted the tree will still act as an obstruction and dimensionally should be spaced a minimum of 4ft plus the expected tree canopy to promote maximum tree growth without hindering the available free space in the **BLUE** zone, shown at bullet 1 of **Figure 4-4 Tree Grates in the Boarding Zone**.



**Figure 4-4** Tree Grates in the Boarding Zone

For information regarding plant type and recommendations for design please reference your local municipality's design standards. **See page 70** for links to some of the local municipality's design guides.

## MICRO-MOBILITY HUBS

There are many types of micro-mobility options ranging from bicycles, electric bicycles, stand up scooters, electric stand up scooters, and even self-balancing vehicles, more commonly known as Segways. COTA recognizes and supports other means of transportation that are used to promote a reduction in vehicular traffic and exhaust emissions. With the introduction of these modes onto the streets, municipalities recognized the need for designated locations to park these devices and created micro-mobility hubs. This section will focus micro-mobility hubs in proximity to the boarding zone area. The interaction between transit and micro-mobility in the roadway will be discussed in **Section 5 Roadway Design**.

Micro-mobility hubs were first introduced as bicycle/scooter racks made of constructed metal tubing mounted to the sidewalk pad. These metal tubed racks are typically no greater than 33 inches in height, for sight visibility purposes, and should be placed in such a way to prevent any portion of the structure or bicycle/scooter from encroaching no more than 2ft to the edge of curb while also providing no less than a 4ft accessible route, as shown in **Figure 4-6 Micro-Mobility in Proximity to a Transit Stop Site** bullet 2. The **RED** zone shall have no less than 5ft of accessible space.

In areas promoting more usage of bicycles and scooters, covered shelters have been incorporated into streetscape design. These shelters are offered and maintained by the city of Columbus. It is recommended any designer and/or developer consult with the city of Columbus on the placement of a Bicycle Shelter. **Figure 4-5 Bicycle Shelter** provides an image of these shelter designs and is shown as bullet 1 of **Figure 4-6 Micro-Mobility in Proximity to a Transit Stop**. Given the overall height and design of these structures it is recommended these shelters be placed at a minimum of 20ft from the downstream edge of the transit stop boarding zone and setback so that any portion of the facility or bicycle does not exceed more than 2ft to the edge of curb. This recommendation is to ensure adequate sight visibility for vehicular traffic when approaching the transit stop site. Additional spacing may be required based on the number of routes serving the transit stop.

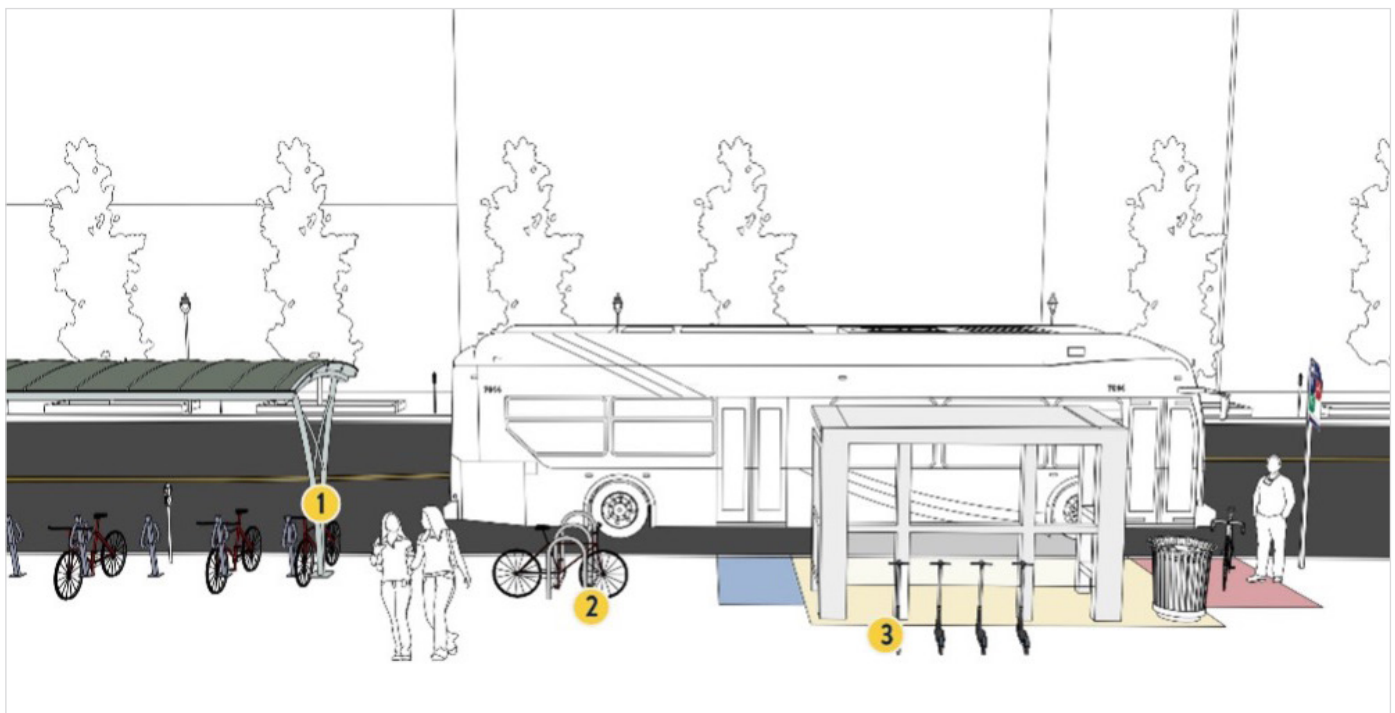


**Figure 4-5** Bicycle Shelter (Image from Columbus Underground)

Newer forms of micro-mobility include electric bicycles, scooters, and Segways. With introduction of electric, comes a need to charge the device when not in use. The docking stations for electric bicycles, scooters, and Segways are typically no taller than 33 inches, however the payment /advertisement portion may be taller for pedestrian accessibility. It is recommended the payment /advertisement structure be placed opposite of the charging stations when downstream or upstream of the boarding zone. This helps reduce congestion within the accessible routes into the boarding zone as shown in bullet 1 of **Figure 4-7 Micro-Mobility Electric Docking Stations**. No portion of the charging station or vehicle should encroach in the ADA landing pad (**RED** zone) and 4ft of accessible clear space shall be allotted in the **BLUE** zone. **NOTE**, these charging stations also require the need for electrical design and the placement of electrical utilities.

In some instances, electric scooters are placed within the Right-of-Way as standalone vehicles. Scooter hubs are typically placed within the city of Columbus and the surrounding municipalities by the scooter rental group. Locations are typically determined based on area optimization and permitted to be placed at said locations by the municipality. Placement of individual electric scooters usually requires a hard surface such as concrete or brick pavers. The placement of pre-charged scooter/Segways should provide a minimum of 4ft of accessible clear space in the **BLUE** zone and not encroach in the **RED** zone.

To ensure maneuverability, for passengers, from a free standing bench or shelter no micro-mobility system shall be placed in the **GOLD** zone. Please consult with the local municipality and COTA for the approval and permitting of any designated free space for the placement of an electric scooter/Segway staging area. If the Right-of-Way is warranted, the placement of scooters/Segways or electric bikes and their respective charging systems may be placed behind the **GOLD** zone as shown in bullet 3 of **Figure 4-6 Micro-Mobility in Proximity to a Transit Stop Site**. A minimum of 4ft should still be allotted for pedestrian traffic.



**Figure 4-6** Micro-Mobility in Proximity to a Transit Stop



**Figure 4-7** Micro-Mobility Electric Docking Stations

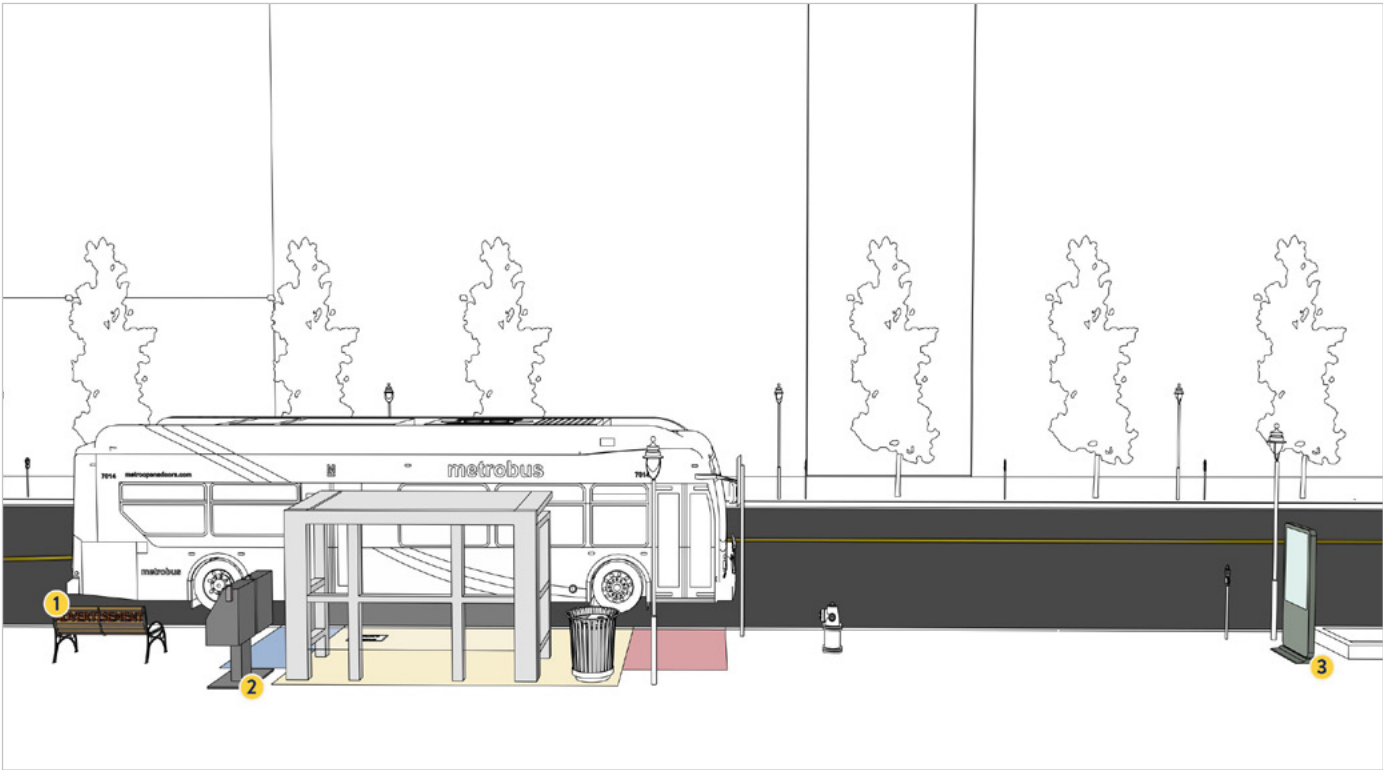
## THIRD PARTY STRUCTURES

Other items that fall within the ROW to be considered are advertising structures, postal collection boxes, and parcel exchange lockers. Advertising structures can range anywhere from magazine stands to advertising benches and even digital kiosk signs. The placement of third party structures within a streetscape must be evaluated with respect to an existing streetscape redesign or brand new streetscape.

When redesigning or updating an existing streetscape, that currently contains magazine stands and/or advertising benches, it is important to be aware of any permitted location for the advertising structure. Should you have any questions regarding a location of an advertising structure, please contact the City of Columbus or the municipal authority in charge of permitting. Permitted structures should be accommodated in design and only be moved within a location if it causes one of the following concerns for pedestrian safety:

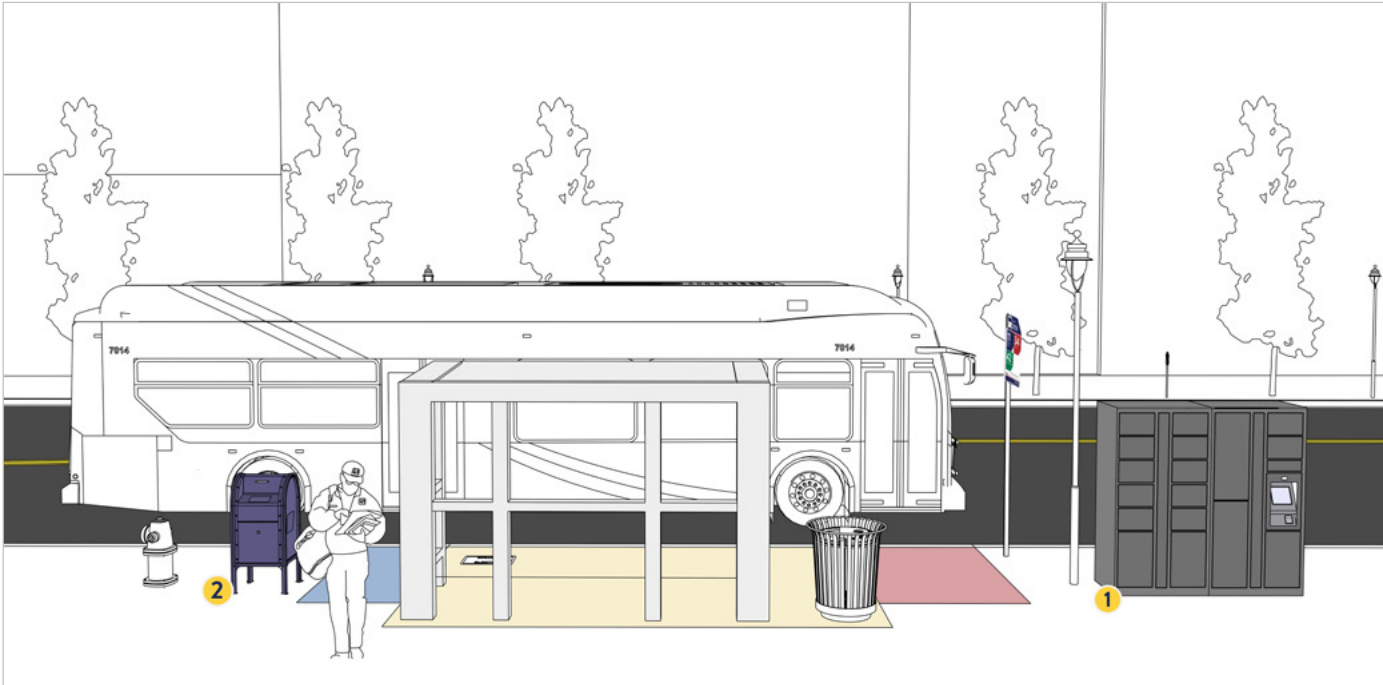
- Obstructs the pedestrian pathway/sidewalk near the boarding zone
- Obstructs the ADA landing pad, **RED** zone
- Obstructs the accessible path to the transit stop site as shown with bullet **1** of **Figure 4-8 Advertising Structure Placement** and **Figure 4-9 Postal Boxes & Parcel Exchange Lockers**.
- Interferes with boarding and alighting of the front and rear doors of the vehicle. but may be placed near the shelter if the **BLUE** zone has 4ft of accessible space as shown with bullet **2** of **Figure 4-8 Advertising Structure Placement** and **Figure 4-9 Postal Boxes & Parcel Exchange Lockers**.
- Obstructs visibility of a transit stop to oncoming vehicles and the transit operator

Digital kiosk signs, as shown in bullet **3** of **Figure 4-8 Advertising Structure Placement**, should be at least 30ft from the transit stop boarding zone and setback at least 2ft from the edge of curb to ensure adequate sight visibility for vehicular traffic approaching the transit stop site. Since digital signs emit light images and can also create a distraction for approaching drivers, it is important to maintain visibility of the transit stop boarding zone at all times. COTA recommends these structures be placed after the transit stop site/boarding zone while maintaining proper movement along the pedestrian pathway and the accessible route to/from the transit stop site. **NOTE**, contact the local municipality for information on digital kiosk sign light restrictions, sizing, and display material.



**Figure 4-8** Advertisement Structure Placement.

**NOTE**, contact the local municipality for information on digital kiosk sign light restrictions, sizing, and display material.

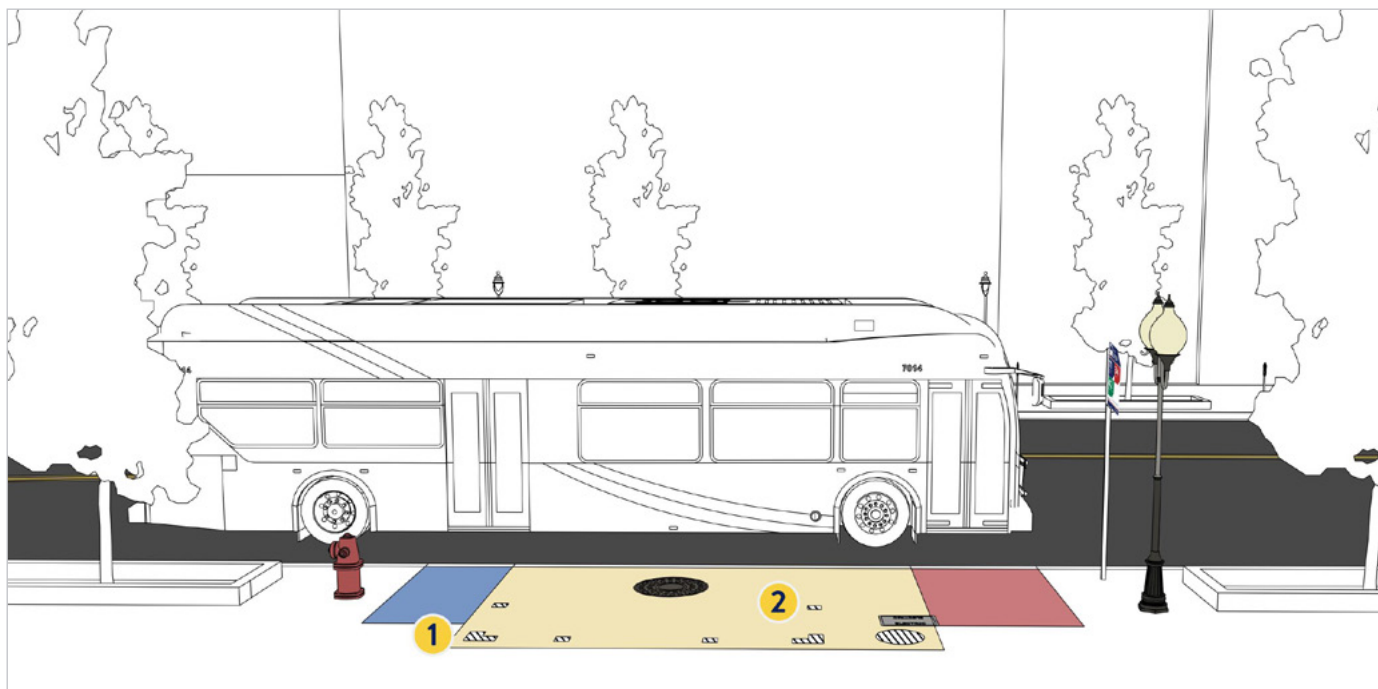


**Figure 4-9** Postal Collection & Parcel Exchange Lockers

# UTILITIES

In most every streetscape design, public utilities will need to be considered. Examples of these utilities can range from natural gas, electric, light, communications, water, fire protection, sanitary relief, and storm water management. When coordinating the placement of a transit stop site it is important to consider the type of utility and where it will be located with respect to the finished elevation of the streetscape. These areas are underground, at surface, or aerial. **NOTE**, please consult the local municipalities design standards for proper placement and interaction of public utilities.

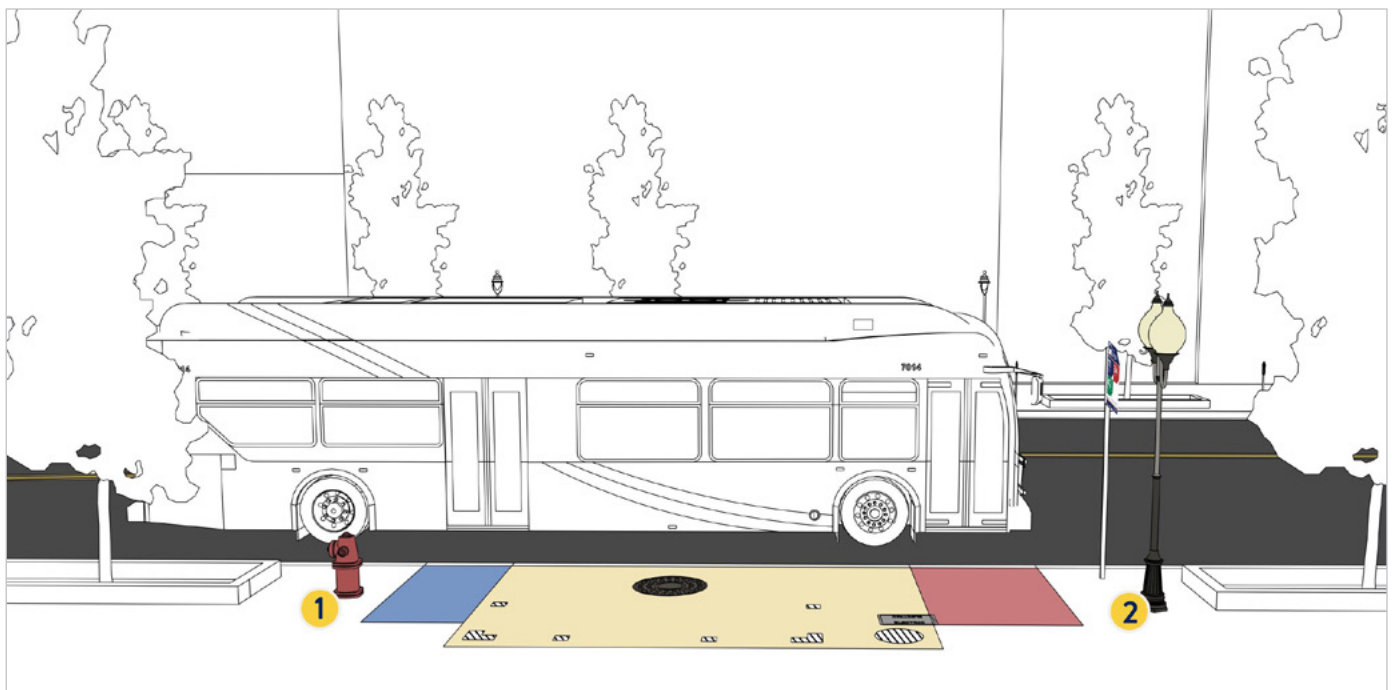
Underground utilities can be placed under a transit stop site, since most require a minimum depth of cover of 12inches or deeper. If a utility is to be placed at a minimum depth of 12inches, it is recommended the COTA transit stop amenity be situated in a manner that does not introduce dead load bearing onto the utility. **NOTE**, COTA's transit stop amenities are installed using anchor bolts in a minimum of 4inch thick concrete pad or other acceptable hard surface, see **Section 3 Transit Stop Site Design**. Bullet **1** of **Figure 4-10 Underground Utility Placement** shows a shelters column placement in grey. Access points such as manhole lids, valve boxes, handhole lids, and meter pit lids for an underground utility may be placed in the **RED/GOLD/BLUE** zones but outside the shelter or **2** bench area at least 2ft to prevent any obstructions during access, see bullet of **Figure 4-10 Underground Utility Placement**. Lids shall be slip resistant and ADA compliant per Section 302.1 of the 2010 ADA Standards. Lids and covers shall be capable of withstanding load ratings of H15 to H20 per AASHTO Load Resistance Factored Design (LRFD) Bridge Design Specifications. **NOTE**, consult the local municipality for any additional design restrictions for lids and covers of underground utilities. In the event utility work is required in a location where a transit stop site is located, the COTA amenities can be dismantled and removed off site by COTA during the duration of work. COTA requires the site be placed back to original or better condition prior to time of construction.



**Figure 4-10** Underground Utility Placement

Surface utilities start as underground utility and then protrude to finished grade and require space within the streetscape. One of these items are fire hydrants. The National Fire Protection Agency (NFPA) requires a minimum of a 36inch clear space to be maintained around the circumference of fire hydrants, found in Section 18.5.7 Clear Space Around Hydrants of the NFPA Fire Code. Fire Department Connections (FDCs) are required to have a clear space not less than 36inches in circumference around the unit and not less than 78inches in height per Section 912.4.2 Clear space around connections of the Ohio Building Code. Gas meters are also required to have at least 36inches of clear space per codes NEC 110-26 and NFPA 54 of the National Fuel and Gas Code. COTA recommends transit stops maintain a minimum of 4ft of clear space around the transit boarding area and be offset to one side of these surface utilities as shown by bullet 1 of **Figure 4-11 Surface Utility Placement**. **NOTE**, if site restrictions require an amenity site to be placed in front of a FDC or Gas Meter, ensure the design of the transit stop site allows for easy access and visibility of these devices.

Another surface utility important to public safety are street lights, highlighted with bullet 2 in **Figure 4-11 Surface Utility Placement**. The City of Columbus Downtown Streetscape Standards require that all street light be placed a minimum of 30 inches from the edge of curb and a minimum of 10ft from street trees. COTA recommends the placement of a street light in proximity to a Transit Stop Site, however, it should not affect the requirements mentioned in **Section 3 Transit Stop Site Design** for the alighting and boarding process as a whole.



**Figure 4-11** Surface Utility Placement

Aerial utilities will consist of the suspended utility and any structures used to support it. The most common aerial utilities found in streetscapes are power and communication lines. These lines are suspended using poles and supported by tension down guys with anchors. Per the National Electric Safety Code (NESC) 232 the minimum vertical clearance for roads, streets, and other areas subject to truck traffic is 15.5ft insulated communication conductors but this height shall increase based on the utility and power supply. Please reference said document for more information. The minimum distance a utility pole or down guy should be placed from the edge of the road is 4ft, however, site restriction allow it to be placed at a minimum of 2ft.



## SECTION 5 | *Roadway Design*

This chapter will discuss the interaction between COTA fleet and the various roadway designs located throughout the Central Ohio District. Site layout and roadway design should incorporate the vehicle properties and operational characteristics described in this manual. Proper design will enhance transit operations and traffic flow, help maintain roadway surfaces, and improve communication between motorists, bicyclists, scooters, pedestrians, and transit operators.



Factors that should be considered when designing or improving a roadway system served by COTA Transit fleet include:

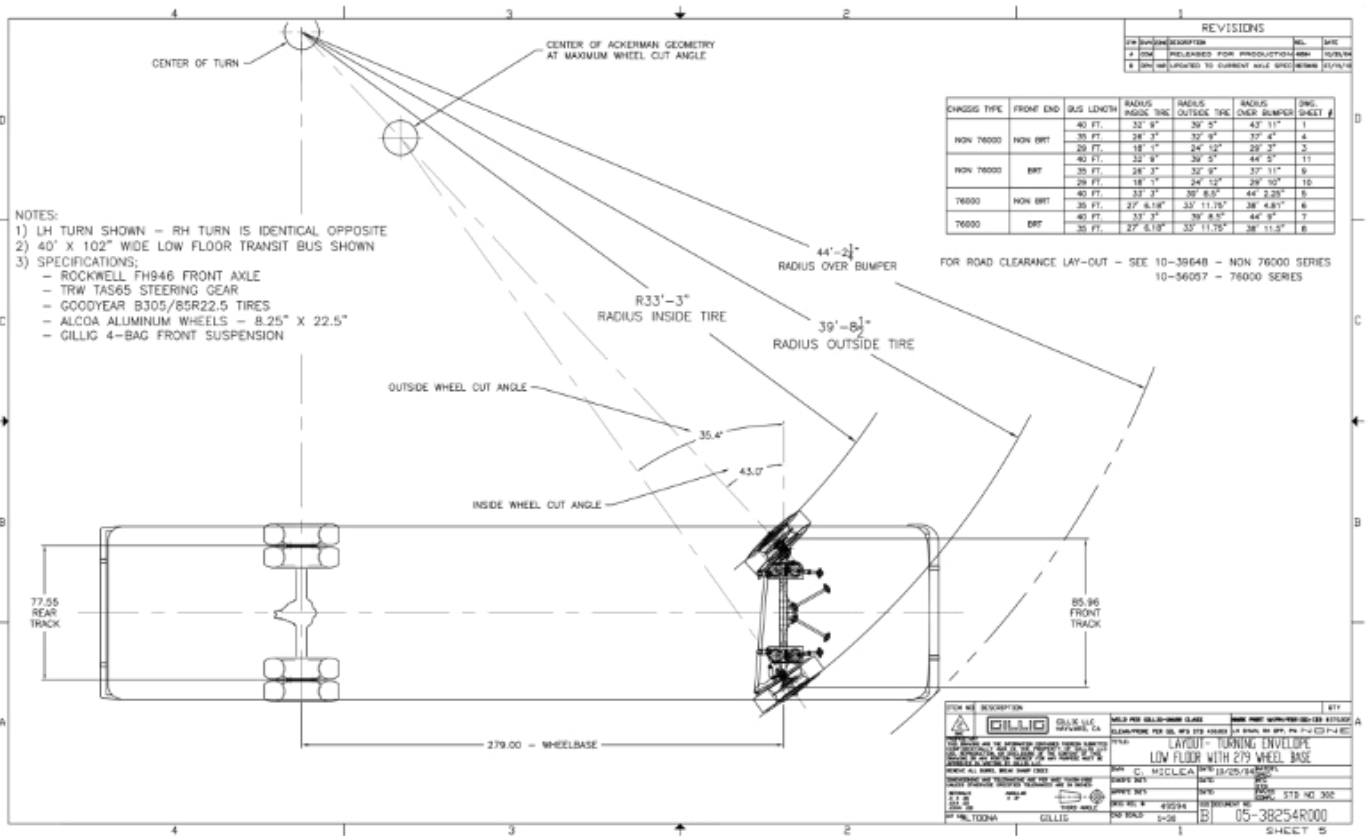
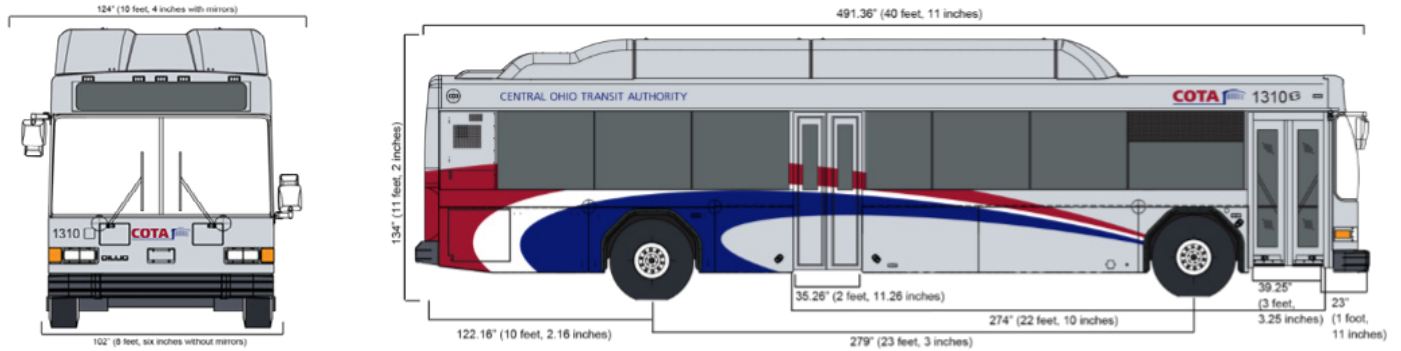
- Transit vehicle characteristics
- On-street parking conditions
- Roadway properties
- Available ROW and surrounding land use
- Vehicle speeds and traffic volume
- Micro-mobility lanes
- Turn radii at intersections and roundabouts

The following roadway design standards set forth in this chapter shall generally conform to or exceed Ohio Department of Transportation (ODOT) minimum design standards and the City of Columbus Construction & Material Specifications Manual while meeting COTA vehicle requirements. These standards are not intended to supersede local regulations established by local municipalities, county, and/or DOT. These agencies should be contacted during the design phase to ensure compliance to all regulations.



# TRANSIT VEHICLE CHARACTERISTICS

COTAs current transit fleet contains vehicles of various sizes, and roadways should be designed to accommodate the largest of COTA's fleet. COTA largest vehicle is approximately 42ft in length (44ft with bike rack), 10ft 4inches in width, and 11ft 2inches in height with a gross vehicle load of 44,533lbs placed over two axles. The load distribution per axles is as follows: 15,873lbs over the front axle and 28,660lbs over the rear. A 42ft transit vehicle consists of the largest turn radii at approximately 50ft and an inner radius of approximately 21.5ft. Where possible, a 60ft outer and 30ft inner radii are ideal for transit operations, however additional design parameters for turning radii can be found in Intersections & Roundabouts in this Section. For design purposes, an AASHTO-2018 City Bus is recommended to be used.



# ROADWAY DIMENSIONS

Traffic lanes used by transit vehicles should be wide enough to permit adequate maneuvering space and safe distance between other vehicles. COTA recommends a minimum lane width of 11ft for roadways subject to transit vehicles. Roadways may be reduced to 10ft minimum during construction events, but this could result in slower speeds and vehicle conflicts and turning conflicts. The minimum height for overhead obstructions should be no less than 13ft from bottom of obstruction to top of pavement, however please reference **Section 4 Utilities** for additional information for minimum vertical clearance when dealing with utilities.

The grade/slope of the roadway can also have an effect on the transit vehicles ability to navigate a route. Changes in grade, whether in the longitudinal direction or cross slope, should be gradual of 6% or less to prevent a transit vehicle from “bottoming out” or causing damage to the vehicle or road.

COTA recommends a curb height of 6 to 8 inches for easy boarding and alighting of passengers, especially those with mobility limitations. Reference the local municipality standard details for design criteria for curbs. Consult with the local municipality or Right-of-Way Jurisdiction for curb design parameters.

# ROADWAY PAVEMENTS

Roadways, both private and public, that will be used by COTA should be designed to support the gross vehicles loads mentioned earlier in this chapter. Contact COTA for verification of roadways actively servicing a route or future route.

Pavement designs for public roadways should reference the parameters set forth in the most recent version of the Ohio Department of Transportation Construction and Material Specifications Manual or governing Right-of-Way jurisdiction. **See page 70** for local design standards.

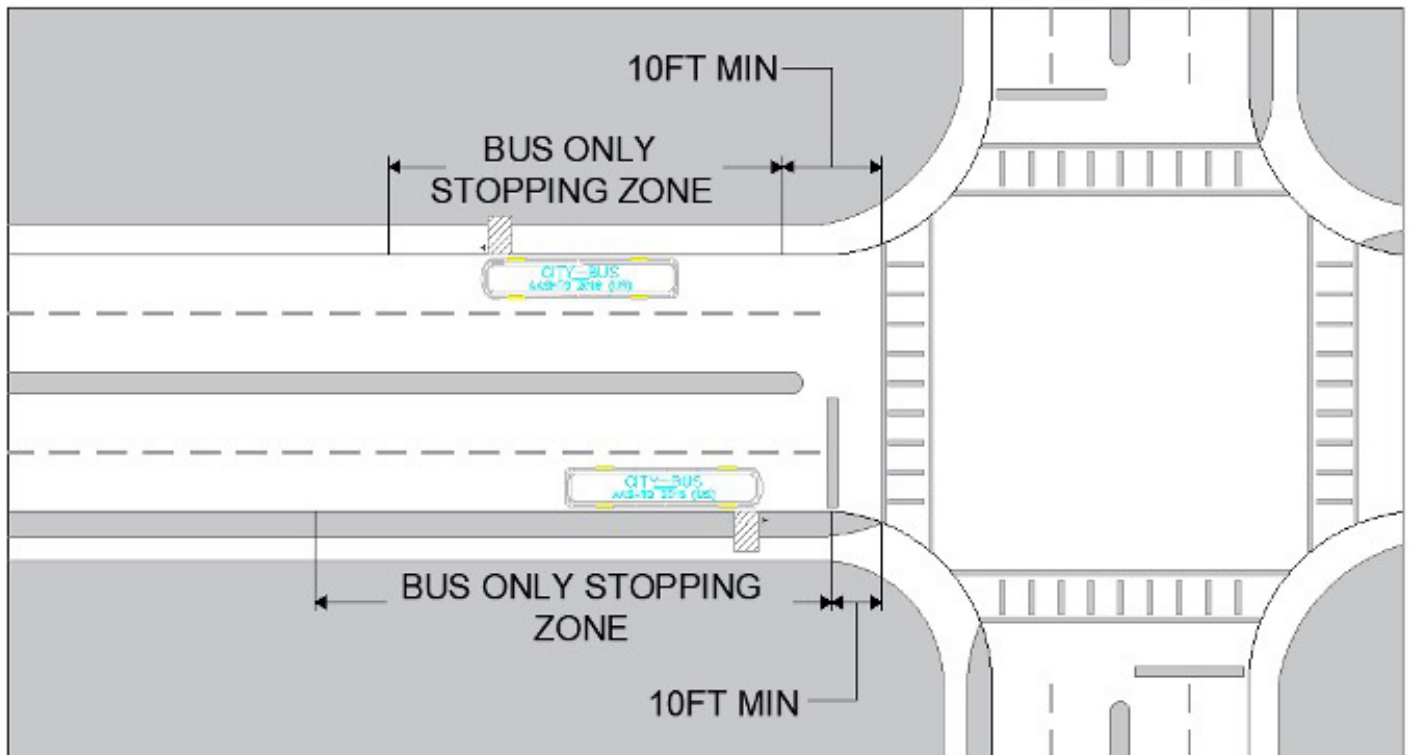
The type of pavement, flexible or rigid, should be designed to support the vehicular type, traffic volume, turning movements, starting and stopping movements of the vehicles, and traffic speeds. COTA and the City of Columbus recommends the use of a rigid pavement for locations at transit stops due to the loads and shear forces applied to the pavement during braking and turning movements of the vehicle. The City of Columbus has established design parameters, listed in standard detail 2332 Concrete Bus Pad, for what is considered the concrete bus pad that is place alongside the transit stop site. **See page 70** for a link to the City of Columbus design parameters established for a concrete bus pad. In some instances, a single transit stop site could support multiple transit lines. COTA should be consulted to determine the number of transit vehicles expected to arrive or dwell at a transit stop at a single time, this could lengthen the bus pad outside the normal design parameters listed in standard detail 2332.

# TRAFFIC SPEEDS *and* VOLUME

When considering transit operations, knowing the design speeds and traffic volumes of the roadway is crucial information. As noted in Transit Stop Spacing of **Section 4 Utilities**, the placement of transit stops creates braking, stopping, and acceleration motions for the vehicle along its route. It is equally important to consider the purpose of the roadway when evaluating a transit vehicles potential to navigate it. Roadways should be recognized as a means to move people and goods from point A to point B, not just as a means to move single occupancy vehicles.

To account for speeds and traffic volumes, transit stops can be situated along the roadside in two general locations: Curbside stops & Stops in a bus bay. **NOTE**, COTA and the local municipality or jurisdiction of the Right-of-Way can assist in the appropriate placement of stops.

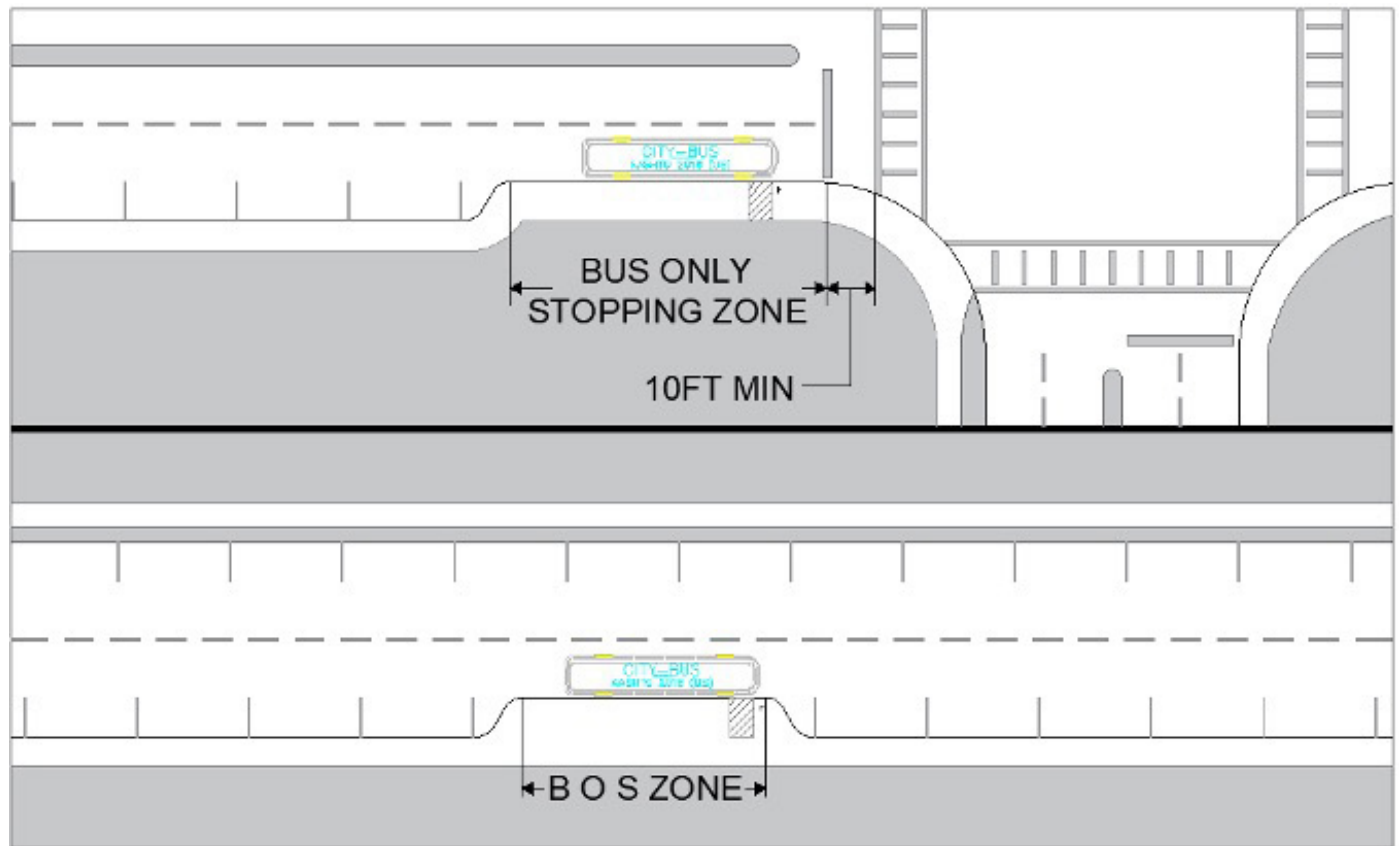
Curbside stops are located along the lane of traffic without the need for the transit vehicle to deviate out of the traffic flow. This design is typically considered in areas where speeds are <35mph, Right-of-Way is restricted in width, low traffic volumes, or transit specific lanes to name a few. All stops should be designated with “Bus Only Stopping” signs. Near-side stops shall have a “Bus Only Stopping” Sign placed up stream of the stop. Far-side stops shall have a “Bus Only Stopping” Sign placed downstream of the stop. Mid-Block stop shall have “Bus Only Stopping” Signs upstream and downstream of the stop. The bus only stopping zone helps to promote the transit vehicle braking, stopping, and acceleration movements. The placement of “Bus Only Stopping” signs on curbside stops shall be based upon the dimensional length of the concrete bus pad for the respective stop location as noted in standard detail 2332. **Figure 5-1 Curbside Stops** provides examples of curbside stop. **NOTE**, “Bus Only Stopping” signs shall be coordinated with the municipality or jurisdiction over the Right-of-Way



**Figure 5-1** Curbside Stops

A hybrid design of a curbside stop is known as a bus bulb. A bus bulb is a curb extension that protrudes into the roadway while allowing the vehicle to remain in the lane of traffic. It is most commonly used when parking is required along the street and/or additional streetscape space is needed to account of high passenger volumes. Bus bulbs should be at least 50ft in length and demarcated by “Bus Only Stopping” Signs at each end of the bus bulb.

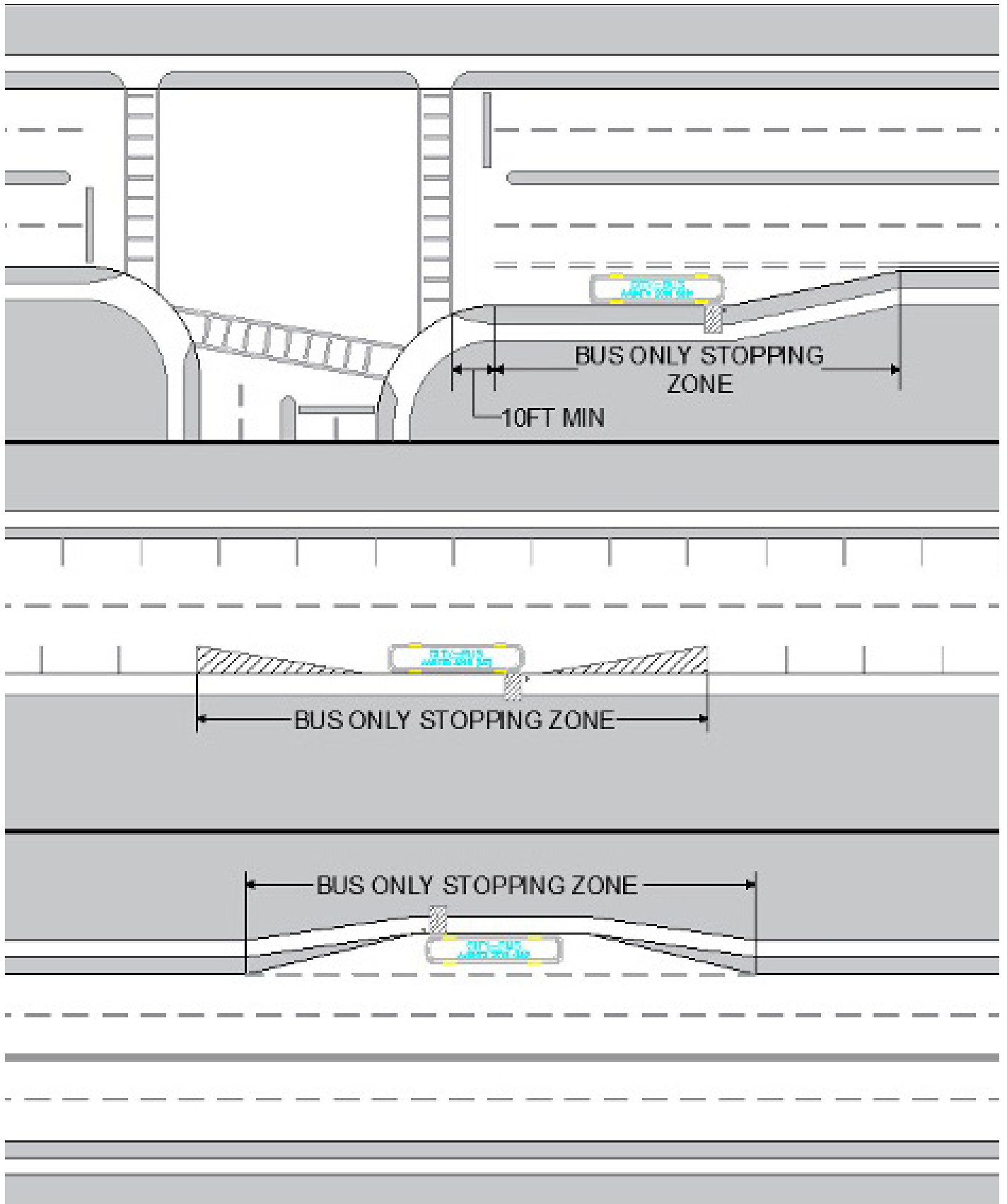
See **Figure 5-2 Bus Bulbs** for examples.



**Figure 5-2** Bus Bulbs

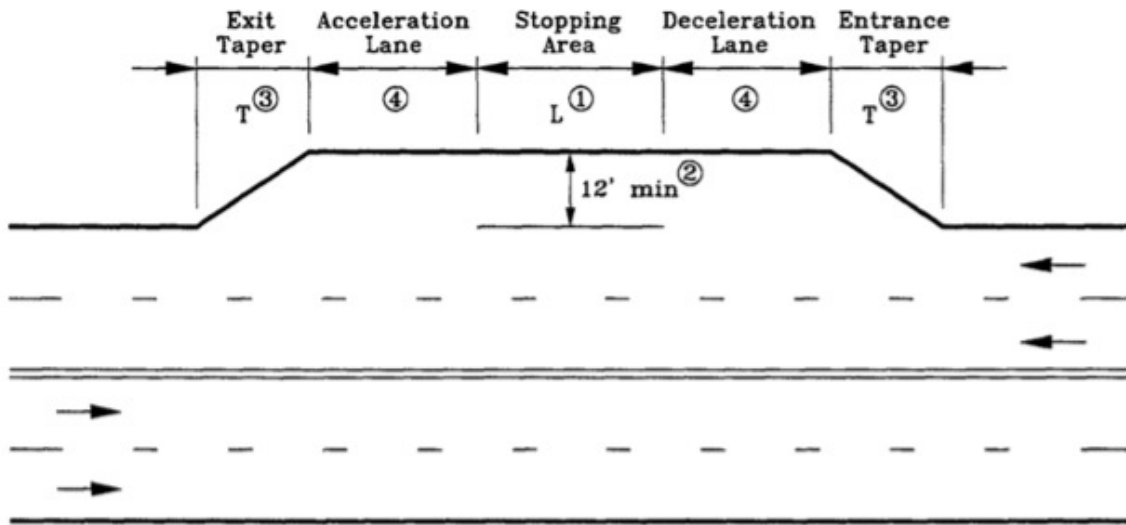
Bus bays are designated zones that allow the vehicle to pull-in and out of the lane of traffic to access a stop. In locations of low traffic volumes, speeds <35mph, extended operator layover periods, operator transfer areas, and end-of-route stops to name a few. The nature of bus bays will require areas with wider Right-of-Ways to accommodate a 11 ft wide shoulder zone or shoulder lane with less dense parking requirements.

At a minimum the length of the bus bay should contain a 50ft pull-in zone, a bus zone of 50ft based upon a 40ft vehicle plus 10ft, and a 50ft pull-out zone. In the event additional routes service a transit stops the bus zone will have to increase an additional 50ft per vehicle depending the transit schedules. COTA will assist with this information. The length of the pull-in zone will vary based on stop placement at an intersection; see Intersections & Roundabouts of this Chapter for more information. **Figure 5-3 Bus Bays** provides examples of these stops. Bus bays should be also be demarcated by “Bus Only Stopping” signs at each end of the bay zone. **NOTE**, consult with the local municipality or jurisdiction over the Right-of-Way for the procurement of Right-of-Way or parking requirements.



**Figure 5-3** Bus Bays

In locations where speeds are >35mph, multi-lanes roads with high traffic volumes exist, and/or operator layover periods occur additional guidelines for bus bay designs should be considered. They are found in the Transit Cooperative Research Program - TCRP Report 19 - "Guidelines for the Location and Design of Bus Stops" shown in **Figure 5-4 TCRP Bus Bay Design**. **NOTE**, consult with the local municipality or jurisdiction over Right-of-Way to determine if these parameters are appropriate based on the traffic design patterns, sight distances and the available space of the roadway in question.



**Notes:**

- 1) Stopping area length consists of 50 feet for each standard 40-foot bus and 70 feet for each 60-foot articulated bus expected to be at the stop simultaneously. See Table 3 for the suggested bus stop capacity requirements based on a range of bus flow rates and passenger service times.
- 2) Bus bay width is desirably 12 feet. For traffic speeds under 30 mph, a 10-foot minimum bay width is acceptable. These dimensions do not include gutter width.
- 3) Suggested taper lengths are listed in table below. Desirable taper length is equal to the major road through speed multiplied by the width of the turnout bay. A taper of 5:1 is a desirable minimum for an entrance taper to an arterial street bus bay while the merging or re-entry taper should not be sharper than 3:1.
- 4) Minimum design for a busy bay does not include acceleration or deceleration lanes. Recommended acceleration and deceleration lengths are listed in the table below.

Through Speed (mph)	Entering Speed <sup>a</sup> (mph)	Length of Acceleration Lane (Feet)	Length of Deceleration Lane <sup>b</sup> (Feet)	Length of Taper (Feet)
35	25	250	184	170
40	30	400	265	190
45	35	700	360	210
50	40	975	470	230
55	45	1400	595	250
60	50	1900	735	270

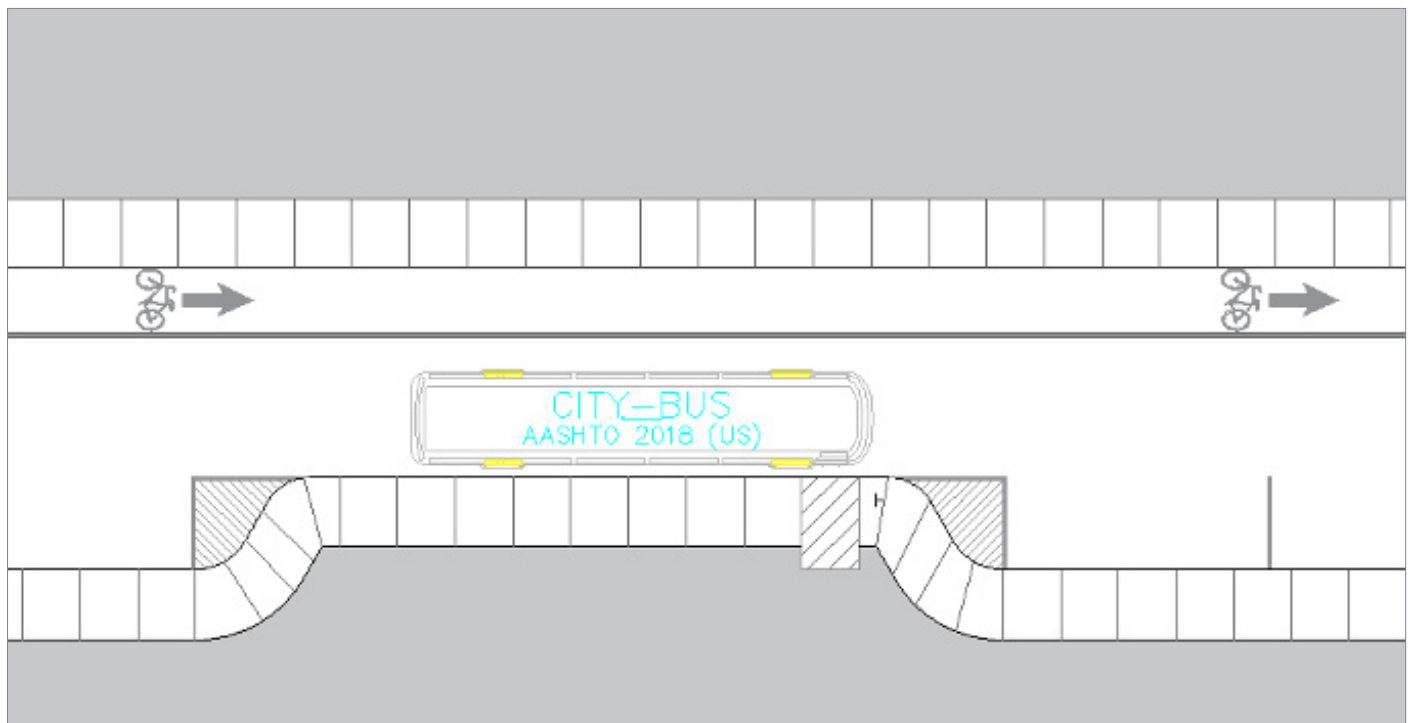
<sup>a</sup> Bus speed at end of taper, desirable for buses to be within 10 mph of travel lane vehicle speed at the end of the taper.  
<sup>b</sup> Based on 2.5 mph/sec deceleration rate.

**Figure 5-4** TCRP Bus Bay Design

# MICRO-MOBILITY LANES

Micro-mobility lanes should provide a safe travel space for bicycles, electric bikes, scooters, electric scooters, and other light weight pedestrian vehicles. Micro-mobility lanes should be clearly marked with the appropriate indicators such as solid white lines, green painted pavement, bicycle and directional arrow markers, and/or buffer zones. The overall width of these lanes are often narrower than a standard vehicular lane. In this section COTA will offer design methods to consider to ensure a safe interaction between transit vehicles, transit stops, and micro-mobility lanes. **NOTE**, the local municipality or Right-of-Way jurisdiction should be consulted to determine the most appropriate micro-mobility lane indicators and width for the roadway in question.

The first option for roadway design, when considering micro-mobility lanes, transit vehicles, and transit stops, is the use of a left side dedicated micro-mobility lane. The appropriate indicators are at the discretion of the municipality or Right-of-Way jurisdiction. The design places the lane on the opposite side of the roadway and away from the side the transit vehicle operates to access transit stops. It also, reduces conflict with potential parking along the right side of the street. **NOTE**, this design method is most commonly used on One-Way streets and is not advisable to be used where opposing traffic is introduced. **See Figure 5-5 Left Side Micro-Mobility Lane** for detail considerations.

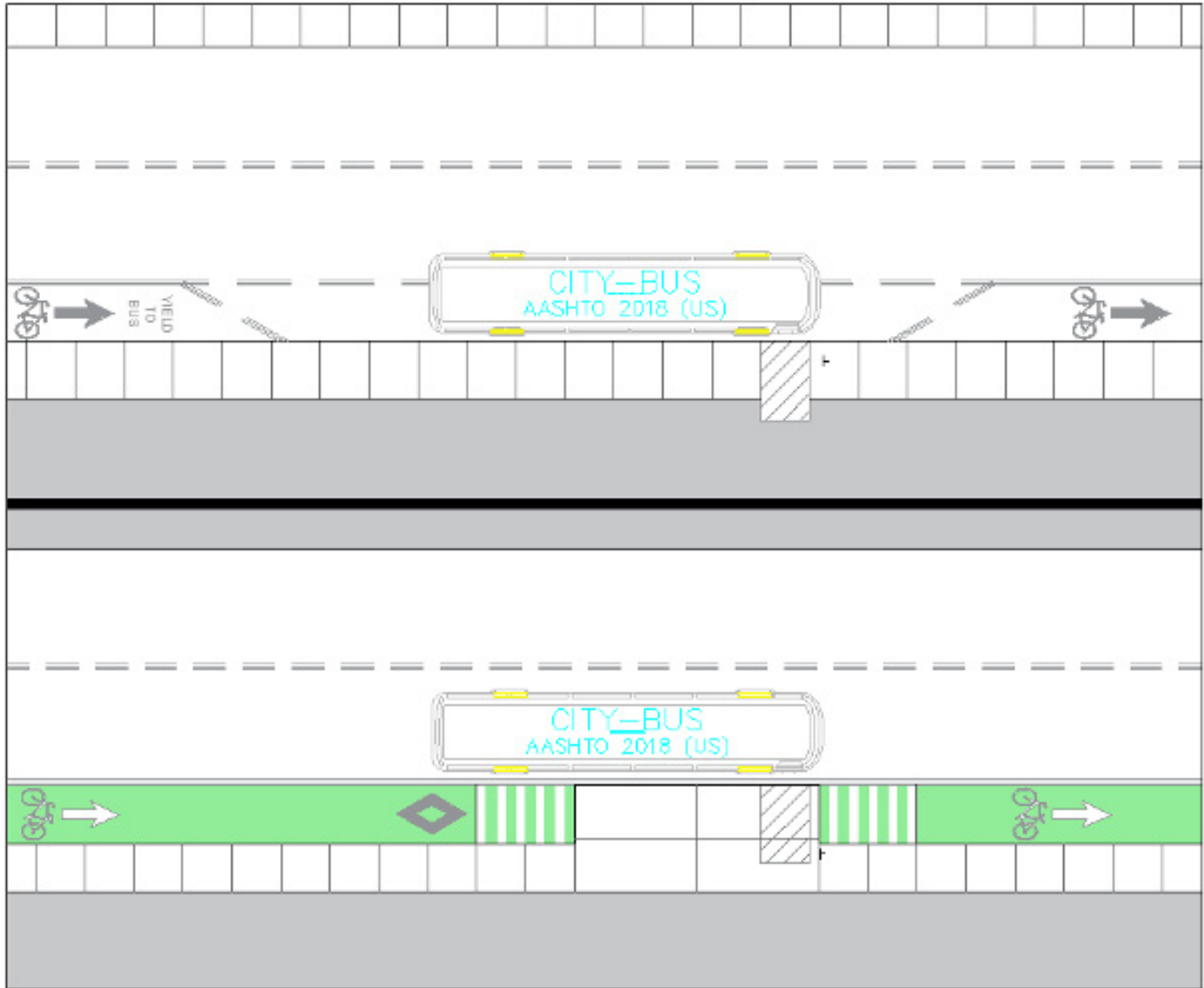


**Figure 5-5** Left Side Micro-Mobility Lane

The second option for roadway design is the use of right side dedicated micro-mobility lane. The appropriate indicators are at the discretion of the municipality or Right-of-Way jurisdiction but could include green paint, lane markers, and/or a combination. Right side micro-mobility lanes are commonly placed along the curbside to prevent interaction with oncoming traffic. However, this does not reduce the interaction with Transit vehicles during the boarding process. To promote a safe interaction, COTA recommends one of two methods. The first option is with the use of dotted lane stripping on the roadway to demarcate a transit yielding zone so that the vehicle can access the transit stop. This provides the transit vehicles an opportunity to access the boarding zone while keeping waiting passengers away from the lanes of travel. It will require micro-mobility users yield to the transit vehicle.



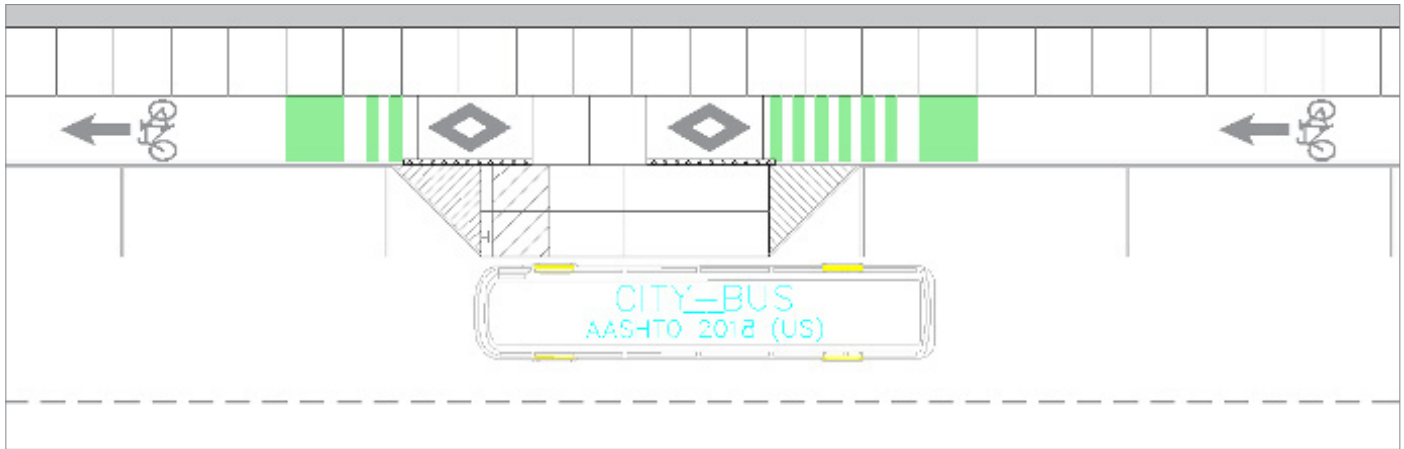
The second option is the use of a bus bulb in combination with ramped edges on each side of the boarding zone. While this method reduces the interaction between micro-mobility and the transit vehicle it does increase the interaction with transit users and will require additional signage and markings to ensure yielding to transit users. The same accessibility parameters for pedestrians listed in **Section 3 Transit Stop Site Design** shall be adhered to when considering option 2. **See Figure 5-6 Curbside Micro-Mobility Lanes** for examples.



**Figure 5-6** Curbside Micro-Mobility Lanes

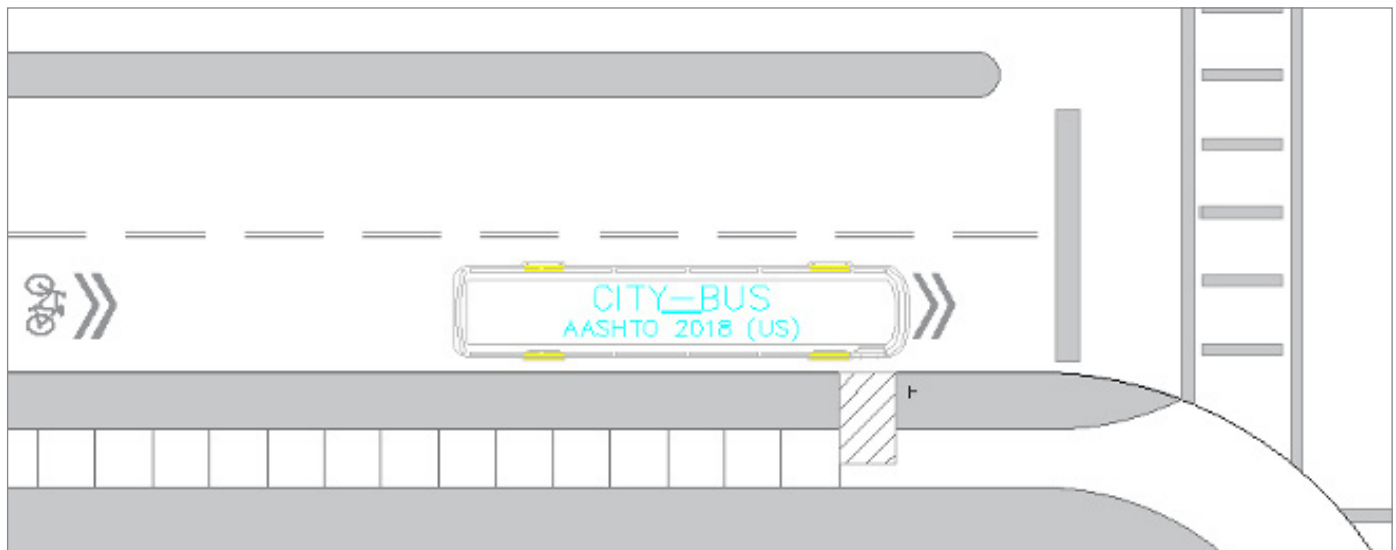
In the event parking has been placed along the roadway, the micro-mobility lane may be placed to either side of the parking area. If the micro-mobility lane is placed left of the parking zone, along the travel lane, the same concepts listed for curbside micro-mobility lanes will apply. Micro-mobility users shall yield to the transit vehicle or to the transit user and pedestrians. To ensure safe interaction with the parking, additional design parameters for bus bays and bus bulbs shall be applied. See Traffic Speeds & Volume of this Chapter.

If the lane is placed nearest the curb, away from the vehicular traffic, COTA prefers the lane to travel remain behind the transit stop to prevent conflict with transit vehicle accessibility to the stop. This design creates a transit boarding island designed per the parameters listed in **Section 3 Transit Stop Site Design**. The micro-mobility lane shall yield to the pedestrian accessible route, connecting to the boarding island, with yield markers or posted signs. COTA recommends the pedestrian accessible route maintain a level connection between the sidewalk and the boarding island and the micro-mobility lane have entry and exit ramps on either side. Otherwise, the accessible route shall be design with the appropriate ADA ramps and accessibility parameters mentioned in Chapter 3. Regardless of the accessible route elevation, the boarding island shall be elevated at a minimum of 6 to 8 inches above the roadway elevation. **See Figure 5-7 Right Side Micro-Mobility Lane with Parking Zone.**



**Figure 5-7** Right Side Micro-Mobility Lane with Parking Zone

The third option for roadway design, implements a shared or combined micro-mobility lane within a vehicular traffic lane. This method is most commonly referred to as a “Sharrow Lane” The combination of lanes could be a result of Right-of-Way restrictions, narrow or limited roadway, low volume traffic flow, and/or mixed transit use. Sharrow lanes are typically the placed in the furthest right lane of traffic, as this is commonly the lane designated for slower traffic. The appropriate indicators are at the discretion of the municipality or Right-of-Way jurisdiction. **See Figure 5-8 Sharrow Lane** for detail considerations. **NOTE:** contact, your local municipality for the most appropriate roadway design when incorporating transit and micro-mobility lanes.



**Figure 5-8** Sharrow Lane

# INTERSECTIONS *and* ROUNDABOUTS

When considering intersection design, it is important to examine the vehicular traffic and pedestrian use in the area. For transit purposes, intersections provide a multitude of functions for both the transit vehicles and its passengers. These functions can include:

- Pedestrian accessibility into and from nearby neighborhoods
- Preferred locations for pedestrian travel with accessible crosswalks (signalized/marked or non-marked)  
**NOTE** - intersections with transit stops should be evaluated by the municipality or Right-of-Way jurisdiction to determine if a crosswalk enhancements are needed.
- Transfer points between intersecting transit routes
- Turning movements, both left-hand and right-hand, for routes changing direction



For transit vehicles, the right hand turn within an intersection can be the most difficult. This is based on the required swing area the transit vehicle must have to prevent it from coming in contact with any surrounding objects.

**Figure 5-9 Intersection Design Cases** provides multiple scenarios of intersection design to ensure adequate swing characteristics without the need for over travel and over steering considerations. The road lane, parking zones, and micro-mobility lane widths shown may vary per local municipality or Right-of-Way jurisdiction design parameters and should only be used as reference for the cases in question. Consult your local municipality or Right-of-Way jurisdiction for complete roadway widths parameters. It is not assumed left hand turns to be non-problematic, however, the resultant radius created by the further space lanes creates a wider turn radius. **NOTE**, when evaluating allotted lanes with signal priority, consider the left hand turn lane and the intersecting right hand turn lane as this could create a conflict of space for two vehicles: one turning right onto the same roadway as a vehicle turning left from.

- Designer should plan for an effective radius of 28' (right rear wheel).
- Transit vehicles are assumed to be 44' in length (with bike rack) by 10'4" in width.
- Assumes no encroachment into opposite lanes.
- Assumes parking is prohibited within 20' of end of curb return
- These are examples, appropriate curb radii must be determined on a case by case basis by the local jurisdiction.

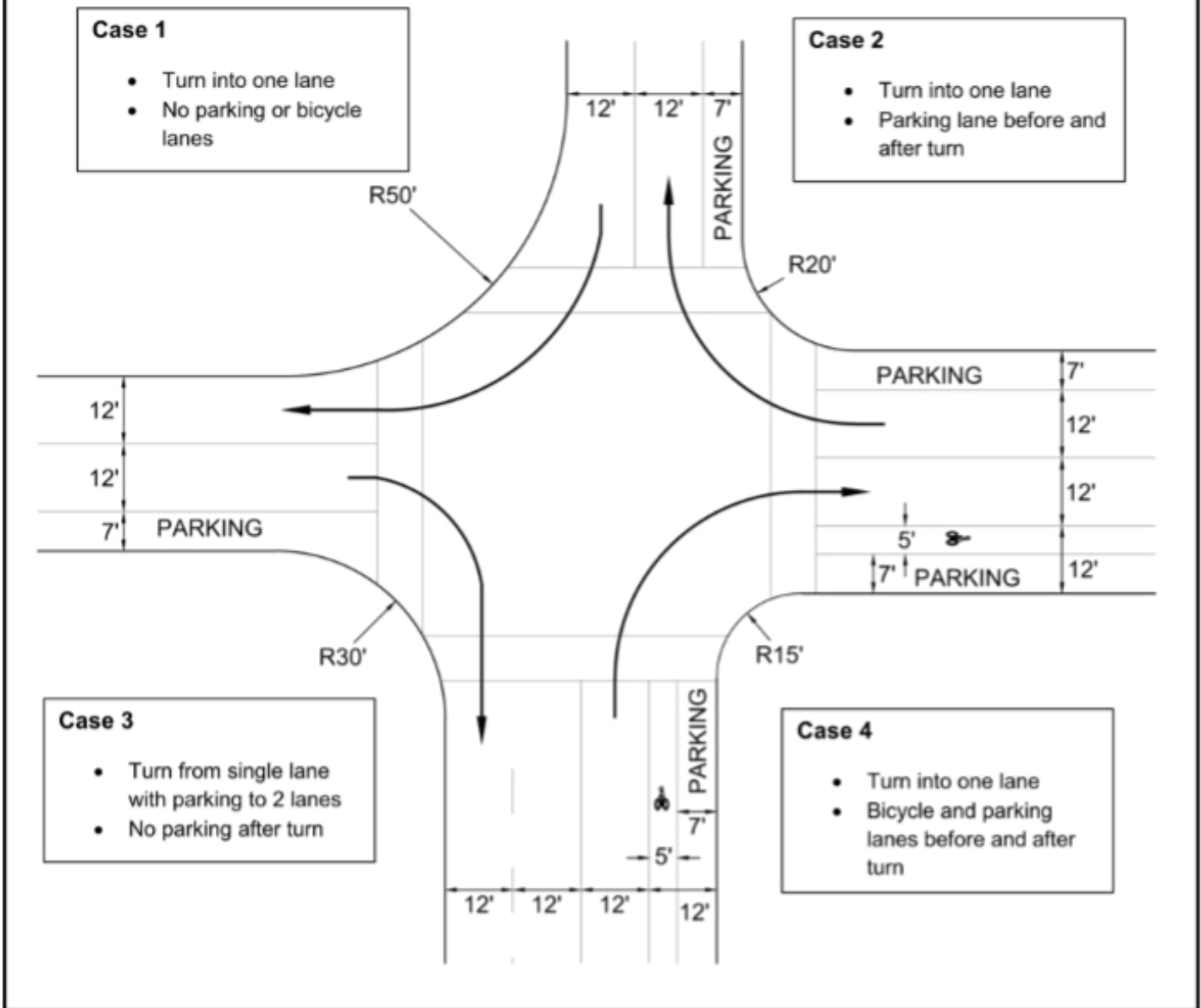
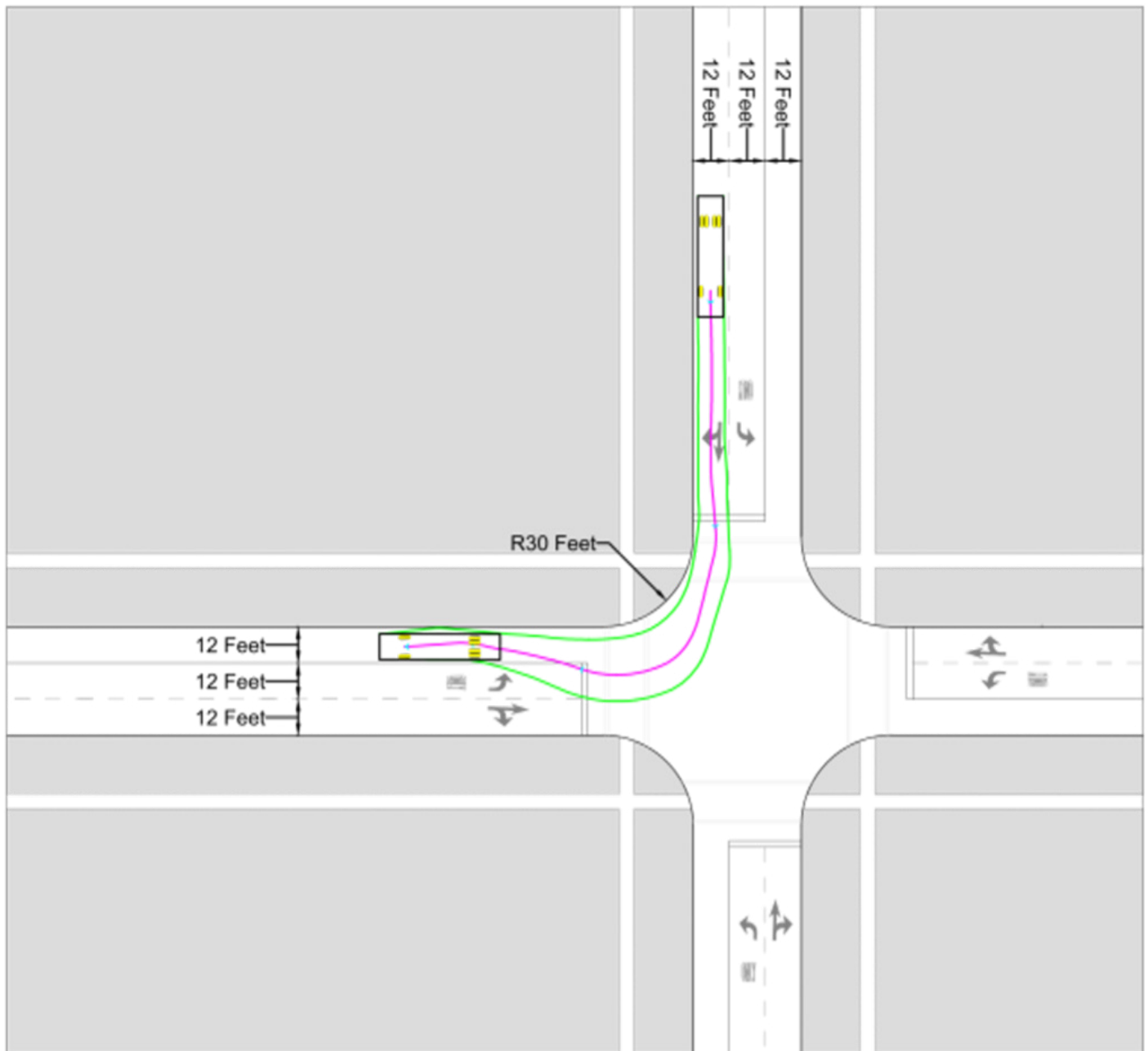


Figure 5-9 Intersection Design Cases

In the event the turn radii parameters listed in **Figure 5-9 Intersection Design Cases** cannot be obtained, the intersection should be designed with over travel and over steering parameters. Over travel and over steering places the vehicle further into the intersection to prevent right side collisions while forcing the vehicle to turn at a slower rate do the over steer. As a result, the vehcile can be forced into the opposing lane of travel while transitioning into its desired lane of travel. To prevent this scenario, the placement of the oncoming Stop Bar should be recessed in the lane of travel as shown in **Figure 5-10 Over Travel and Over Steer**. **NOTE**, the Ohio Manual on Uniform Traffic Control Devices (OMUTCD) states the typical stop bar placement is a minimum of 4ft, but no more than 30ft, from the edge of the intersecting roadway or established crosswalk. In the event turning radius increases this placement, please consult the local municipality or Right-of-Way jurisdiction for information on sight triangle requirements, visual cues options, and/or intersection redesign.



**Figure 5-10** Over Travel and Over Steer

Mentioned in **Section 4 Streetscape Design**, the two stops most influenced by intersection design are near-side and far-side stops. The functions of intersection stops listed earlier in this section make these locations the most ideal for transit use. However, each of these stops consist of advantages and disadvantages that must be considered, listed in **Table 5.1 Characteristics of Transit Stops and Intersections**. To confirm the placement or relocation of a stop during the design or redesign of an intersection please consult COTA for assistance.

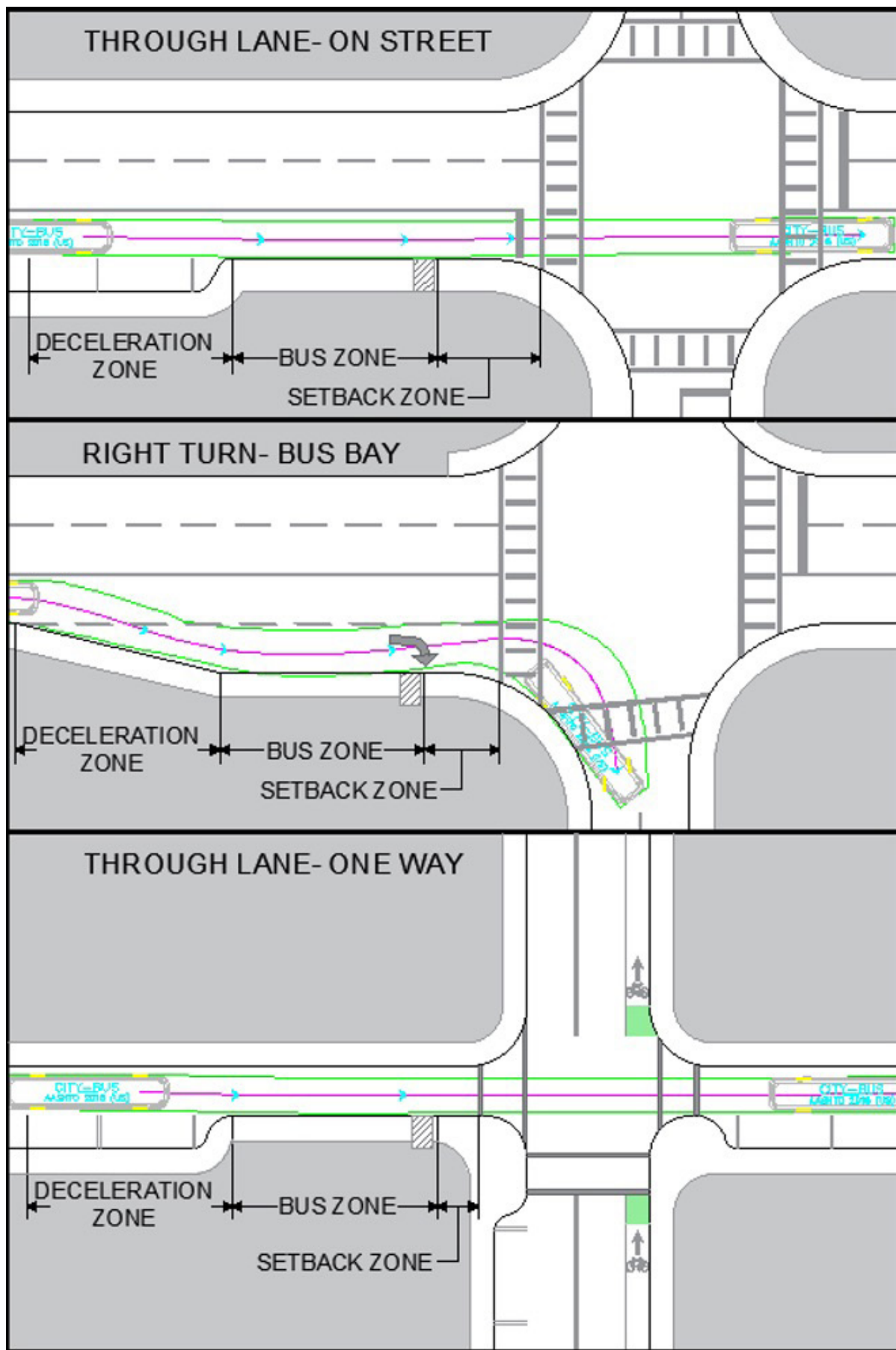
Location Related to Intersection	ADVANTAGES	DISADVANTAGES	WHERE RECOMMENDED
<b>NEAR-SIDE</b>	<ul style="list-style-type: none"> <li>Minimizes interference when traffic is heavy on the far side of the intersection</li> <li>Allows passengers to access vehicles closest to the crosswalk</li> <li>Results in the width of the intersection being available for the driver to pull away from curb</li> <li>Eliminates double stopping</li> <li>Allows passengers to board and alight while the vehicle is stopped at a red light</li> <li>Provides driver with opportunity to look for oncoming traffic</li> </ul>	<ul style="list-style-type: none"> <li>Increases conflicts with right-turning vehicles</li> <li>May result in stopped vehicles obscuring curbside traffic control devices and crossing pedestrians</li> <li>May cause sight distance to be obscured for cross vehicles stopped to the right of the transit vehicle</li> <li>May block the through lane during peak period with queuing vehicles</li> <li>Increases sight distance problems for crossing pedestrians as through traffic passing vehicles on the left may not be able to see the pedestrians attempting to cross in front of the transit vehicle</li> </ul>	<ul style="list-style-type: none"> <li>Traffic is heavier on the far-side</li> <li>Existing pedestrian conditions are better than on the far-side</li> <li>Pedestrian movements are safer on near-side</li> <li>Transit route continues straight through the intersection</li> </ul>
<b>FAR-SIDE</b>	<ul style="list-style-type: none"> <li>Minimizes conflicts between right-turning vehicles and transit.</li> <li>Provides additional right turn capacity by making curb lane available for traffic</li> <li>Minimizes sight distance problems on approaches to intersection</li> <li>Encourages pedestrians to cross behind the vehicle</li> <li>Transit vehicles making left hand turns</li> <li>Creates shorter deceleration distances for vehicles and minimizes area needed for curbside bus zone</li> <li>Results in operators taking advantage of gaps in traffic flow created at traffic signals</li> </ul>	<ul style="list-style-type: none"> <li>May result in intersections being blocked during peak periods by parked vehicles</li> <li>May obscure sight distance for crossing vehicles</li> <li>May increase sight distance problems for pedestrians</li> <li>Can cause a vehicle to stop far-side after stopping for a red light (double stopping)</li> <li>May increase number of rear-end accidents since drivers do not expect vehicles to stop again after a red light</li> <li>Could result in traffic queued into intersection</li> <li>May interfere with right turn movement from cross street</li> </ul>	<ul style="list-style-type: none"> <li>There is a high volume of turns</li> <li>Route alignment requires left turn immediately before stop</li> <li>Complex intersections with multi-phase signals or dual turn lanes</li> <li>Traffic is heavier on the near-side</li> <li>Existing pedestrian conditions are better on far-side</li> <li>Traffic conditions and signals may cause delays if near-side</li> <li>Intersections have transit signal priority treatments</li> </ul>

**Figure 5.1** Characteristics of Transit Stops at Intersections

Near-side stops consist of three zones. The first area is the deceleration zone or pull-in zone, if the stop is within a bus bay. The deceleration zone should be a minimum of 50ft in length. See Traffic Speeds and Volumes of this Section for more information on bus bays. The second area is the bus zone, the space a transit vehicle will occupy while boarding and alighting is taking place. This zone should be a minimum of 50ft in length per 40ft transit vehicle using the stop at single time. The third area is the setback zone. This zone is measured from the transit stop sign to the nearest edge of the crosswalk. Minimum setback distances with respect to the crosswalk are as follows:

- Bus on One-way road at signalized or Stop sign controlled intersection- Minimum setback distance is 10ft. If the roadway has parking, the use of a bus bulb is encouraged to provide better access to the crosswalk and reduce the sight distances with the parking in the area.
- Bus on Two-way road at signalized or Stop sign controlled intersection, curbside stop on through lane of travel - Minimum setback distance is 10ft. **NOTE**, evaluation of sight distances and bi-secting roadway turning movements should be considered.
- Bus on Two-way road at signalized or Stop sign controlled intersection w/ pull-in bus bay - Minimum setback distance is 30ft. **NOTE**, near-side pull-in bus bays should be reserved for routes making a right hand turn, otherwise the bus must be allowed to transition through the intersection safely and continue in a lane of travel or be provided an allotted merge zone on the far-side. At a minimum this merge zone should be at least 50ft in length from the edge of the crosswalk and include a 50ft pull-out zone.
- Bus on Multi-lane roads at signalized intersection curbside stop or pull-in bus bay - Minimum setback distance is 30ft.
- Bus on Multi-lane roads at signalized intersection w/ Leading Pedestrian Interval (LPI)- Minimum setback distance is 10ft.
- Bus on Multi-lane road at uncontrolled intersection - Minimum setback distance shall be calculated based on the line of sight triangle for the pedestrian, the speed of the roadway, and the vehicle considered to be the sight obstruction.

**See Figure 5-11 Near-side Stops** for examples of these intersections. For additional assistance please consult the local municipality or jurisdiction of the Right-of-Right and COTA.



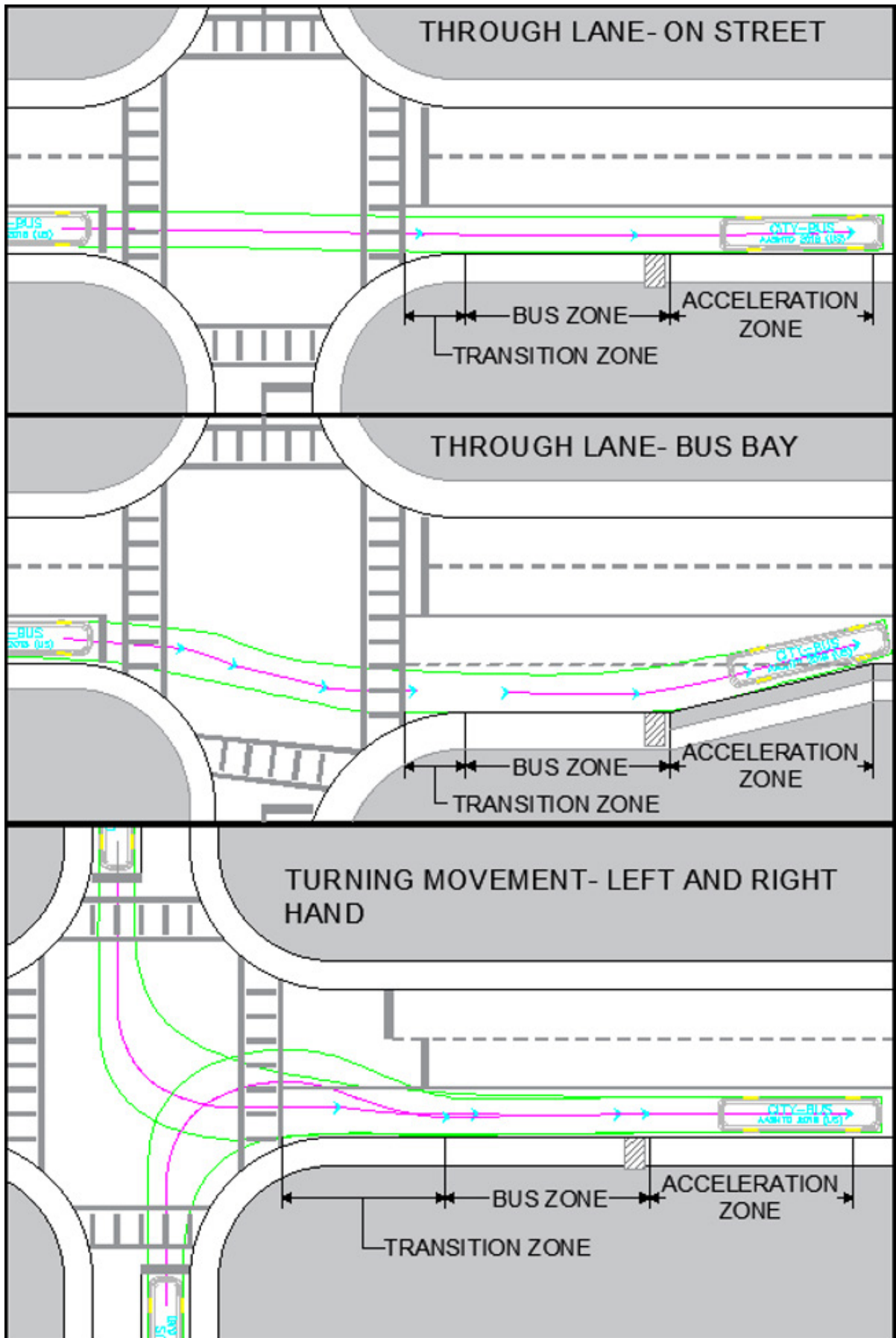
**Figure 5-11** Near-Side Stop



Far-side stops will also consist of three zones. The first area is the transition zone. This zone will vary in length based on the direction of travel of the bus. Straight through travel reduce the length of this zone; while, turning movements of the bus from the intersecting lanes will require additional length. This zone is measured from the nearest edge of the crosswalk to the beginning of the bus zone. Minimum transition distances with respect to the crosswalk are as follows:

- Bus on One-way road at signalized or Stop sign controlled intersection through travel- Minimum transition distance is 10ft.
- Bus on Multi-lane road at signalized or Stop sign controlled intersection w/ pull-in bus bay through travel- Minimum transition distance is 15ft.
- Bus on Multi-lane road at signalized or Stop sign controlled intersection, curbside stop on through lane of travel- Minimum transition distance is 25ft.
- Bus on multi-lane road at signalized or Stop sign controlled intersection, curbside or pull-in bus bay from left hand turn- Minimum transition zone is 40ft.
- Bus on multi-lane road at signalized or Stop sign controlled intersection, curbside or pull-in bus bay from right hand turn- Minimum transition zone is 55ft.

The second area is the bus zone, the space a bus will occupy while boarding and alighting is taking place. This zone should be a minimum of 50ft in length per 40ft transit vehicle using the stop at single time. The third area is the acceleration zone or pull-out zone, if the stop is in a bus bay. This zone should be a minimum of 50ft in length starting at the Transit Bus Sign. **See Figure 5-12 Far-side Stops** for examples of these intersections.



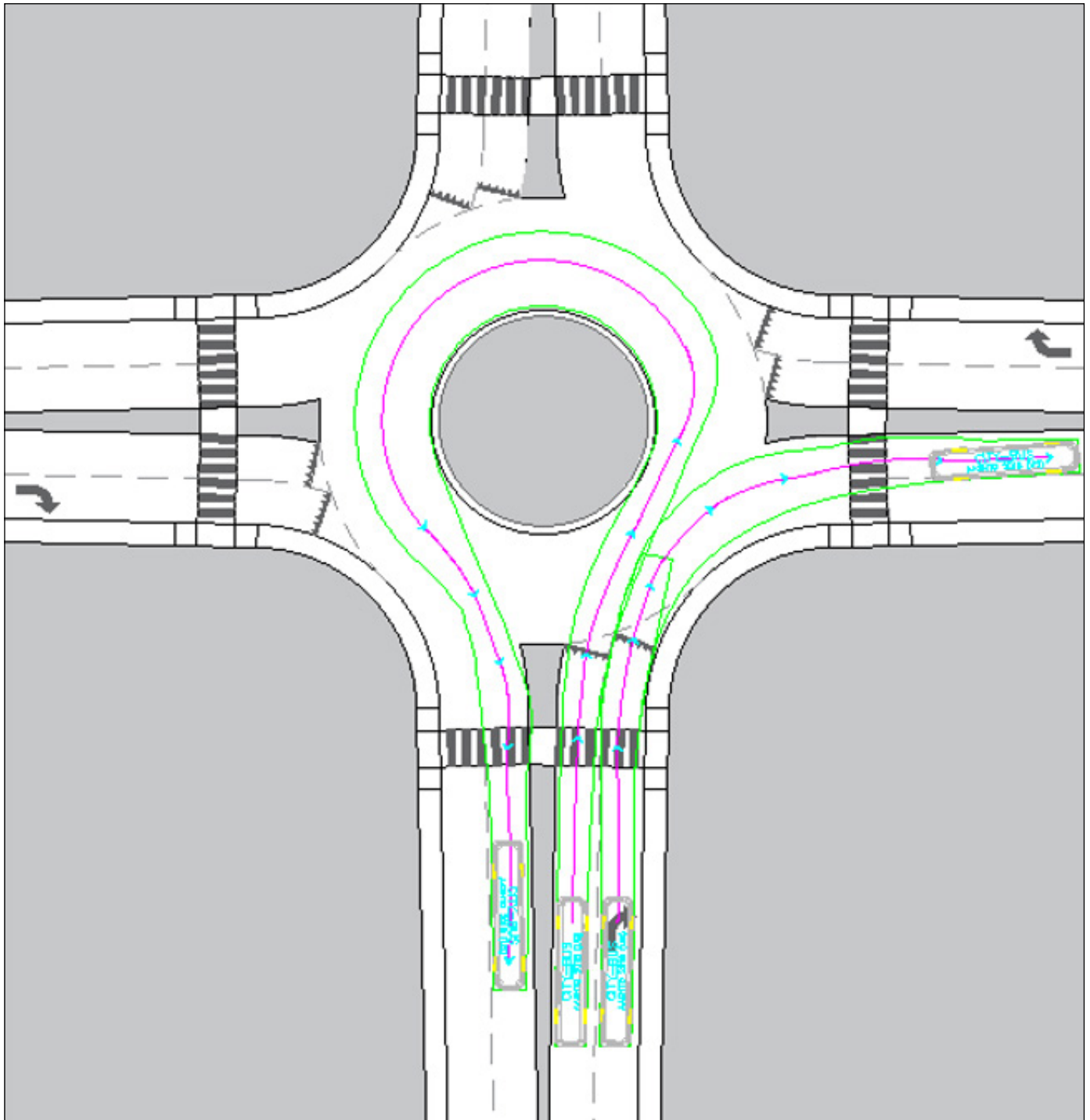
**Figure 5-12** Far-side Stops

Roundabouts are beneficial when it comes to improving traffic flow between intersecting roadways. Like typical intersections, roundabouts can also pose an issue with turning movements of transit vehicles. Chapter 6 Geometric Design of the NCHRP Report 672 - "Roundabouts an Informational Guide" provides minimum design criteria for the movement of specific vehicles within a roundabout. This report recognizes four roundabout design types and their respective vehicle sizes to ensure the appropriate inscribed circle diameter and is listed in **Table 5.2 Typical Inscribed Circle Diameter Ranges**.

Roundabout Configuration	Typical Design Vehicle	Common Inscribed Circle Diameter Range
<b>MINI-ROUNDABOUT</b>	SU-30	<b>45ft to 90ft</b>
<b>SINGLE-LANE ROUNDABOUT</b>	B-40 WB-50 WB-67	<b>90ft to 150ft</b> <b>105ft to 150ft</b> <b>130ft to 180ft</b>
<b>MULTILANE ROUNDABOUT (2-LANES)</b>	WB-50 WB-67	<b>150ft to 220ft</b> <b>165ft to 220ft</b>
<b>MULTILANE ROUNDABOUT (3-LANES)</b>	WB-50 WB-67	<b>200ft to 250ft</b> <b>220ft to 300ft</b>

**Table 5.2** Typical Inscribed Circle Diameter Ranges

While transit vehicles are not directly listed within the chart, the AASHTO-2018 City Bus design vehicle was interpolated based on vehicle length and axle spacing shown in Transit Vehicle Properties of this Chapter. For the purpose of transit vehicles the roundabout should have an inscribed circle diameter of no less than 120ft with a center island diameter no greater than 60ft. The entrance and exit radii should be at least 50ft to promote smoother turning movements in and out of the roundabout. A reduction in these dimensional parameters may result in slower movements and the potential to occupy multiple lanes during maneuvering. **See Figure 5-13 Roundabouts** for an example.



**Figure 5-13** Roundabouts

The placement of stops both near- or far-side of roundabouts will take into consideration the same parameters set forth for intersection design including the number of lanes, directional turn lanes, and even the direction of the transit routes. However, roundabouts are designed to promote more driver and pedestrian awareness to create a yielding mentality during traffic flow. As a result, the potential for continual, steady movement through the roundabout is increased with less starting and stopping movements. As result, it is COTA's preference to place transit stops Near-side of a roundabout because this area is in a state of deceleration while in approach to the roundabout and it is supporting one route of traffic flow and volume. If the design requires the placement of the stop on the far-side of the roundabout, COTA recommends additional coordination between the municipality or Right-of-Way jurisdiction and COTA.

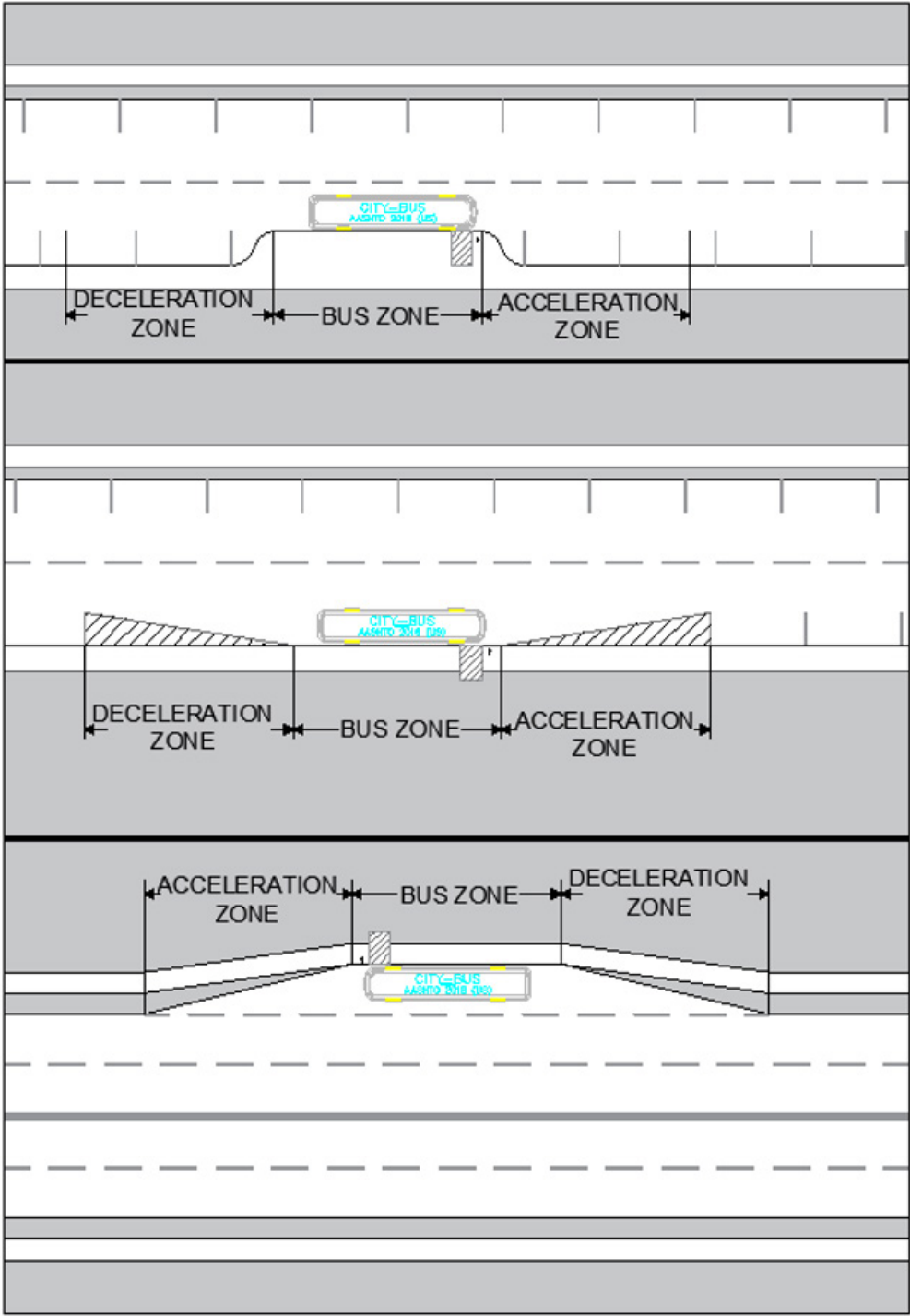
## MID-BLOCK TRANSIT STOPS *and* CROSSWALKS

In some instances the placement of a mid-block transit stop may be required. This could be a resultant of adequate transit spacing requirements, locations of origin or destination locations, or even intersection design parameters preventing the placement of stops within the preferred proximity of a near- or far-side stops. **Table 5.3 Characteristics of Mid-Block Transit Stops** offers a more in depth explanation for advantages, disadvantages, recommended locations for the placement of Mid-block stops.

Location Related to Intersection	ADVANTAGES	DISADVANTAGES	WHERE RECOMMENDED
<b>MID-BLOCK</b>	<ul style="list-style-type: none"> <li>Minimizes sight distance problems for vehicles and pedestrians</li> <li>May result in passenger waiting areas experiencing less pedestrian congestion</li> <li>May be closer to passenger origins or destinations on long blocks</li> </ul>	<ul style="list-style-type: none"> <li>Minimizes sight distance problems for vehicles and pedestrians</li> <li>May result in passenger waiting areas experiencing less pedestrian congestion</li> <li>May be closer to passenger origins or destinations on long blocks</li> <li>Requires additional distance for no parking restrictions</li> <li>Encourages unsafe pedestrian crossing</li> <li>Increases walking distance for patrons crossing intersections, or requires special features for patrons crossing at mid-block locations</li> </ul>	<ul style="list-style-type: none"> <li>When the route alignment requires a right turn and curb radius is short</li> <li>Problematic traffic conditions at the intersection</li> <li>Passenger traffic generator is located mid-block</li> <li>Compatible with corridor or district plan</li> </ul>

**Chart 5.3** Characteristics of Mid-Block Stops

Like near-side and far-side stops, mid-block stops may be placed curbside, along a bus bulb if there are parking restrictions, or in a bus bay if traffic speeds and volume are high. Additional information of these stop locations can be found in Traffic Speeds & Volume of this Chapter. Mid-block stops will also consist of three zones: a deceleration, pull-in zone when in a bus bay, a bus zone, and an acceleration, pull-out zone when in a bus bay. The first zone, deceleration or pull-in zone, should be a minimum of 50ft in length. The second zone, bus zone, should be a minimum of 50ft per 40ft transit vehicle using the stop at a single time. The third zone, acceleration or pull-out zone, should be a minimum of 50ft in length. **See Figure 5-14 Mid-Block Stops** for example layouts.

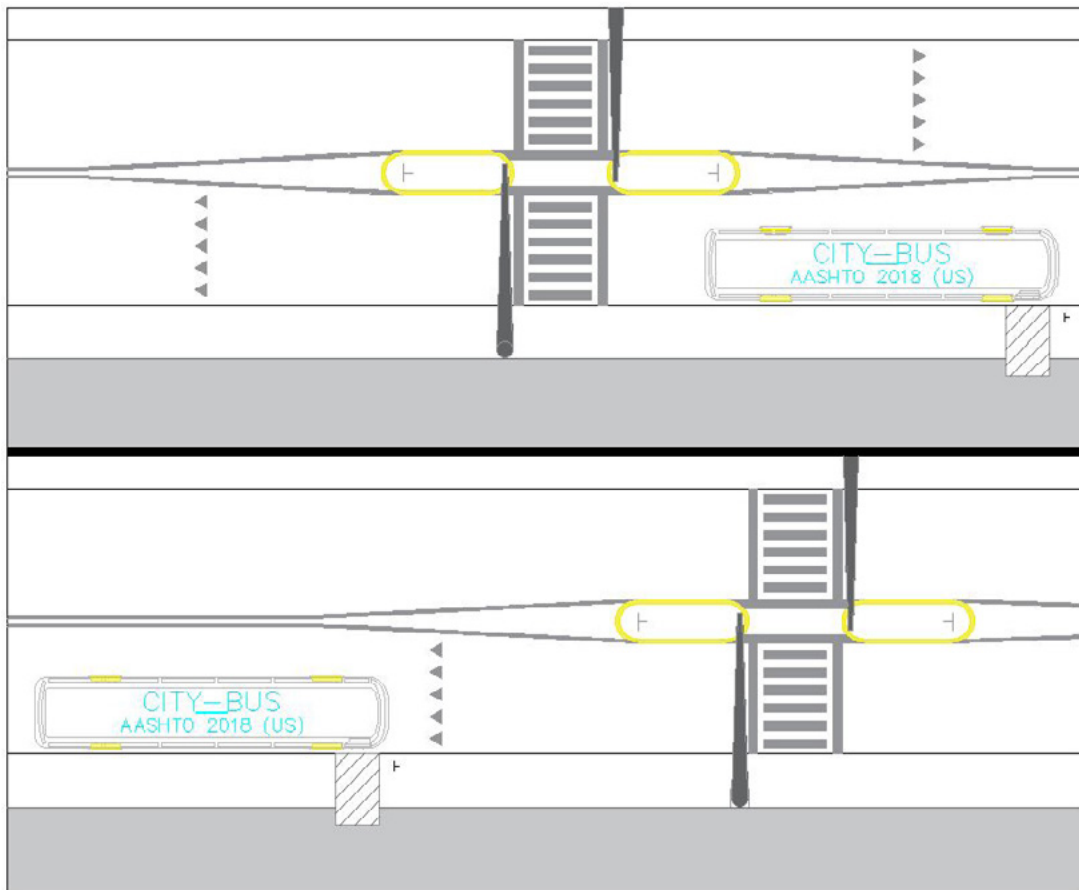


**Figure 5.14** Mid-Block Stops

Mid-Block stops alone are beneficial when the stop destination is located along the same side of the roadway, however in most circumstances transit users may be placed in a situation where a point of origin or destination is on the opposite side of the roadway. According to the Federal Highway Administration the average person is willing to walk a 1/4 to 1/2 mile to a transit stop. The placement of a mid-block stop, due to a point of origin, destination, or spacing requirements, may require a person to walk longer distances to reach an intersection with a designated crosswalk. To prevent improper crossing of roadways, COTA recommends mid-block transit stops be placed in proximity or pairing to a designated pedestrian crosswalk. The type of designated crosswalk should be coordinated with the municipality or governing jurisdiction of the Right-of-Way. In an effort to coordinate with multiple cross walk types, COTA offers the following recommendations:

- The desirable placement for transit stops is far-side of the crosswalk. The crosswalk should not be obstructed by the rear portion of the transit vehicle at any time while also providing enough space to allow adequate sight distance for traffic. **NOTE**, the Manual on Uniform Traffic Control Devices (MUTCD) has established parameters on the recommended minimum distance based upon the design criteria of the pedestrian sight triangles. Likewise, the stop should not be placed up to a distance too far that would encourage pedestrians to not utilize the established cross walk based on the characteristics of the development in the area.
- In the event a near-side stop is needed based on development characteristics of the area the MUTCD should be consulted based on the recommended crosswalk design.

Other considerations such as parking and micro-mobility lanes should be noted and provided the allotted transition spacing for the bus to operate within the “Bus Only Stopping” zone. **See Figure 5-15 Mid-Block Stops and Dedicated Crosswalks** for a visual representation.



**Figure 5.15** Mid-Block Stop and Dedicated Crosswalks



## SECTION 6

### *Placemaking Design*

One feature of a great transit system is the built environment that treats this system as multi-functional. A system's stops and stations can serve a multitude of functions, including placemaking. Placemaking is a means to leverage a locations' assets, inspiration and potential, with the intention of creating public spaces that promote people's health, happiness and well-being. There are multiple ways to address transit stops as hubs for community activities. From where a transit stop is located in the public right-of-way, to public art and landscaping, to how development can cluster convenient goods and services around such stops, recognizing stops as part of our social infrastructure is a highly effective means to elevating transit in our community's conscience and create more positive travel experiences. The following guidelines are an introduction to transit stops as placemaking:



# SPECIALTY STOPS

COTA's stops are gateways to Central Ohio's unique and diverse communities. Some transit stop locations present opportunities for unique placemaking interventions like public art, landscaping, or customized designs for amenities like shelters or benches. Where feasible COTA is interested in partnering with communities, businesses, or individuals to make special improvements to transit stops. The following criteria should be considered before engaging COTA to discuss special placemaking interventions: (1) all interventions must meet the safety, operational, and accessibility criteria outlined in this guide, (2) community partners requesting special placemaking interventions may be asked to provide financial support, labor, or other assets in support of the project, (3) COTA's stops are typically located in the public right-of-way meaning designs must be approved by local government jurisdictions. Parties interested in securing standard amenities like shelters, benches, or trash cans at a transit stop are encouraged to review COTA's Transit Amenity Contribution Program before requesting specialty placemaking interventions.



**Figure 6-1** COTA worked with the Capital Square Review Board to design unique shelters to compliment the historic character of the Ohio Statehouse, a National Historic Landmark.

# TRANSIT STOP PARKLETS

Parklets are semi-permanent sidewalk extensions that create space for park-like amenities like planter boxes and seating. Parklets are sought after amenities in many cities, particularly in business districts where sidewalk space for outdoor seating is limited. Parklets are typically built in space that would otherwise be on-street parking. Transit stop parklets combine the familiar concept of a parklet with a transit stop by building within bus stop zones. Transit stop parklets yield operational benefits to COTA similar to those of bus bulbs listed in Traffic Speeds & Volume of Chapter 5 Roadways while providing additional space for rider amenities like shelters and benches. Transit stop parklets can also be used to beautify streetscapes and promote traffic calming. Third parties interested in partnering with COTA to install bus stop parklets are encouraged to contact the COTA Development Division, COTA will coordinate with the local municipality or Right-of-Way Jurisdiction **Figure 6-2 Transit Stop Parklet** offers an example of such design.



**Figure 6-2** Transit Stop Parklet

# TACTICAL URBANISM

Tactical boarding platforms or bus stop bulbs are made of modular, temporary materials that can be quickly assembled at transit stops. These treatments are operationally similar to transit stop parklets but are more utilitarian in nature and lack park-like amenities. Operational benefits of these treatments are the same as bus stop bulbs listed in Traffic Speeds & Volume of **Section 5 Roadways** and include reduced reentry delay, additional space for passenger amenities, and increased ease of passenger boarding, particularly if the platform is constructed to allow for near level boarding. Ideally tactical platforms are made of durable materials that can be redeployed at multiple locations. COTA is exploring opportunities to deploy tactical boarding platforms/bus bulbs in Central Ohio.

## COTA ART PROGRAM

COTA strives to bring art into the transit riding environment to make riding COTA a more fun and engaging experience while making our transit stops and facilities a sources of community pride. COTA Loves Art is a program that works with artists to make engaging works of public art at COTA transit stops, vehicles, and other facilities. Art installed at transit stops via the COTA Loves Art program should utilize standard transit stop amenities listed in **Section 3 Transit Stop Site Design** and not conflict with any of the safety or accessibility provisions outlined in this guide. Staff from the COTA Development Division will support artists with the information they need to ensure projects meets all requirements outlined in this guide. More information on the COTA Loves Art program will be provided on COTA.com in the near future.



# TRANSIT AMENITY CONTRIBUTION PROGRAM

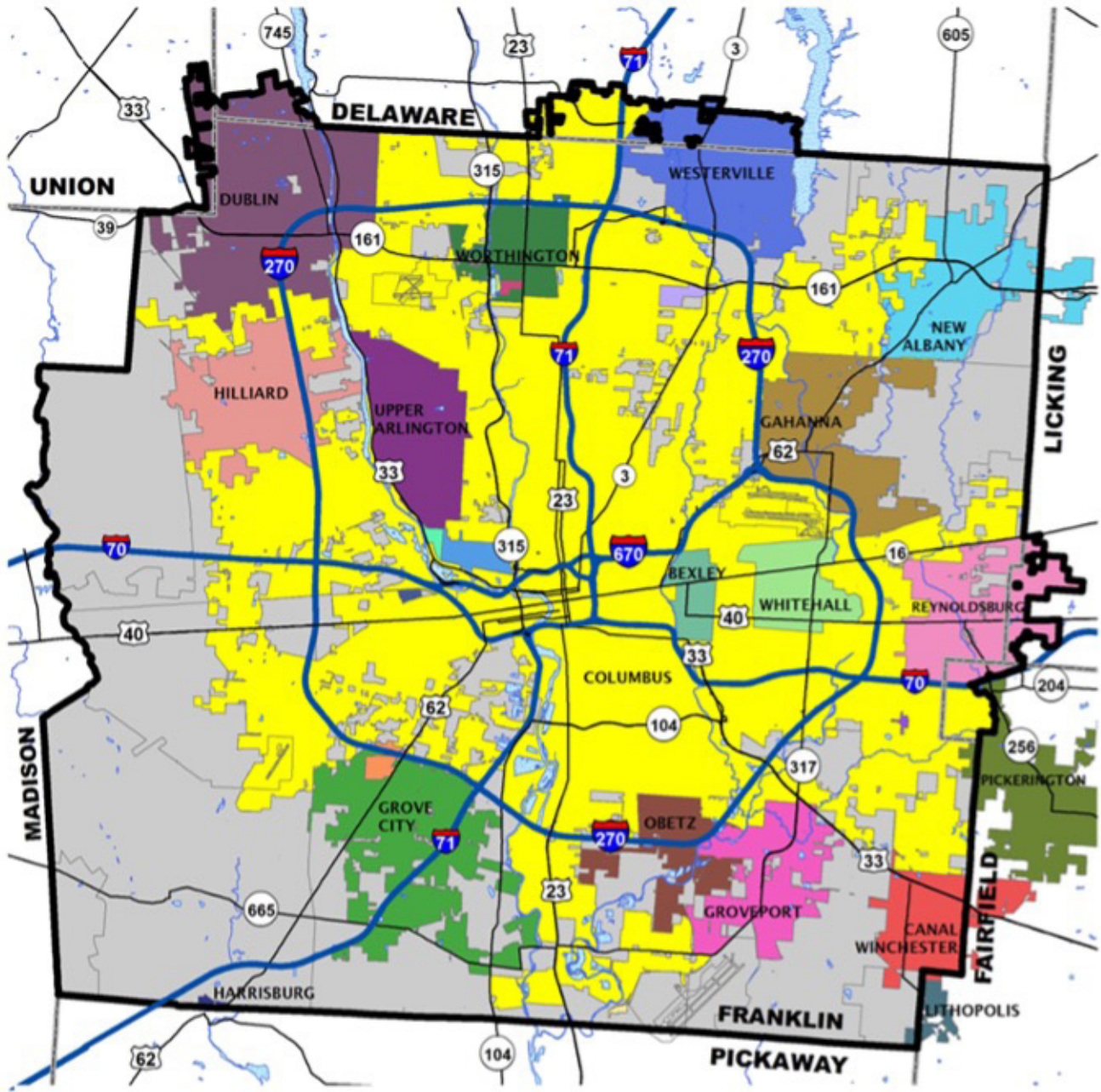
In order to maximize opportunities to enhance waiting conditions at our stop locations, COTA has created a partnership program that will allow individuals and organizations to contribute funds towards a desired stop amenity of their choice at qualifying locations. Instances where COTA criteria does not warrant an amenity, such as a transit shelter, seating option or shelter lighting, COTA is willing to offset some of the administrative costs associated with obtaining that item when the contributing party financially contributes towards the item and any needed site improvement costs. The tax deductible contribution provides COTA with additional amenity items and allows for a greater number of our transit stop locations to enjoy an improved customer experience.

# APPENDIX

Specifications and Figures



COTA Taxing District



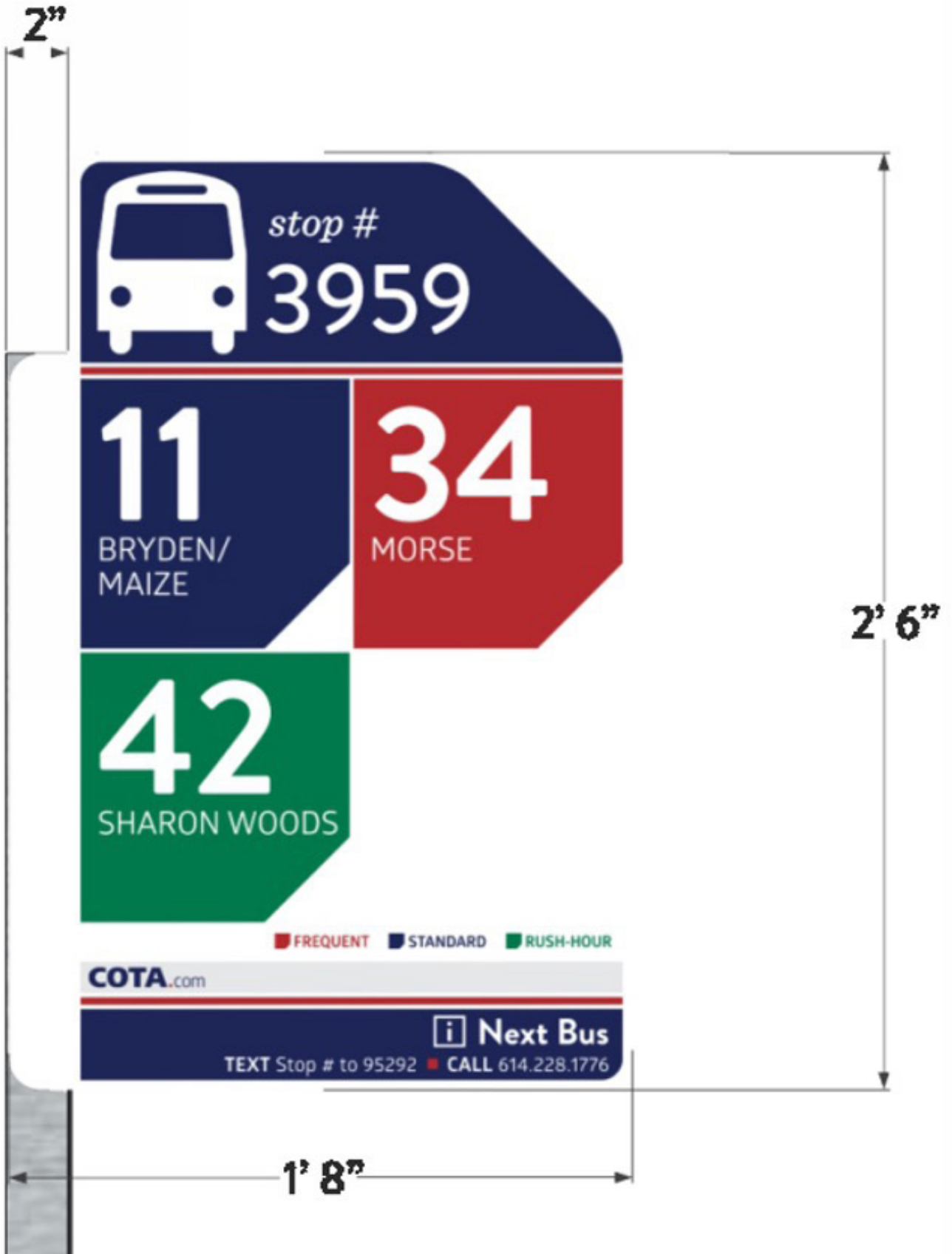
Legend

COTA Taxing District	<b>CORPORATIONS</b>	GAHANNA	LITHOPOLIS	PICKERINGTON	WESTERVILLE
County Boundaries	BEXLEY	GRANDVIEW HEIGHTS	LOCKBOURNE	REYNOLDSBURG	WHITEHALL
Water	BRICE	GROVE CITY	MARBLE CLIFF	RIVERLEA	WORTHINGTON
	CANAL WINCHESTER	GROVEPORT	MINERVA PARK	UPPER ARLINGTON	Franklin County
	COLUMBUS	HARRISBURG	NEW ALBANY	URBANCREST	
	DUBLIN	HILLIARD	OBETZ	VALLEYVIEW	

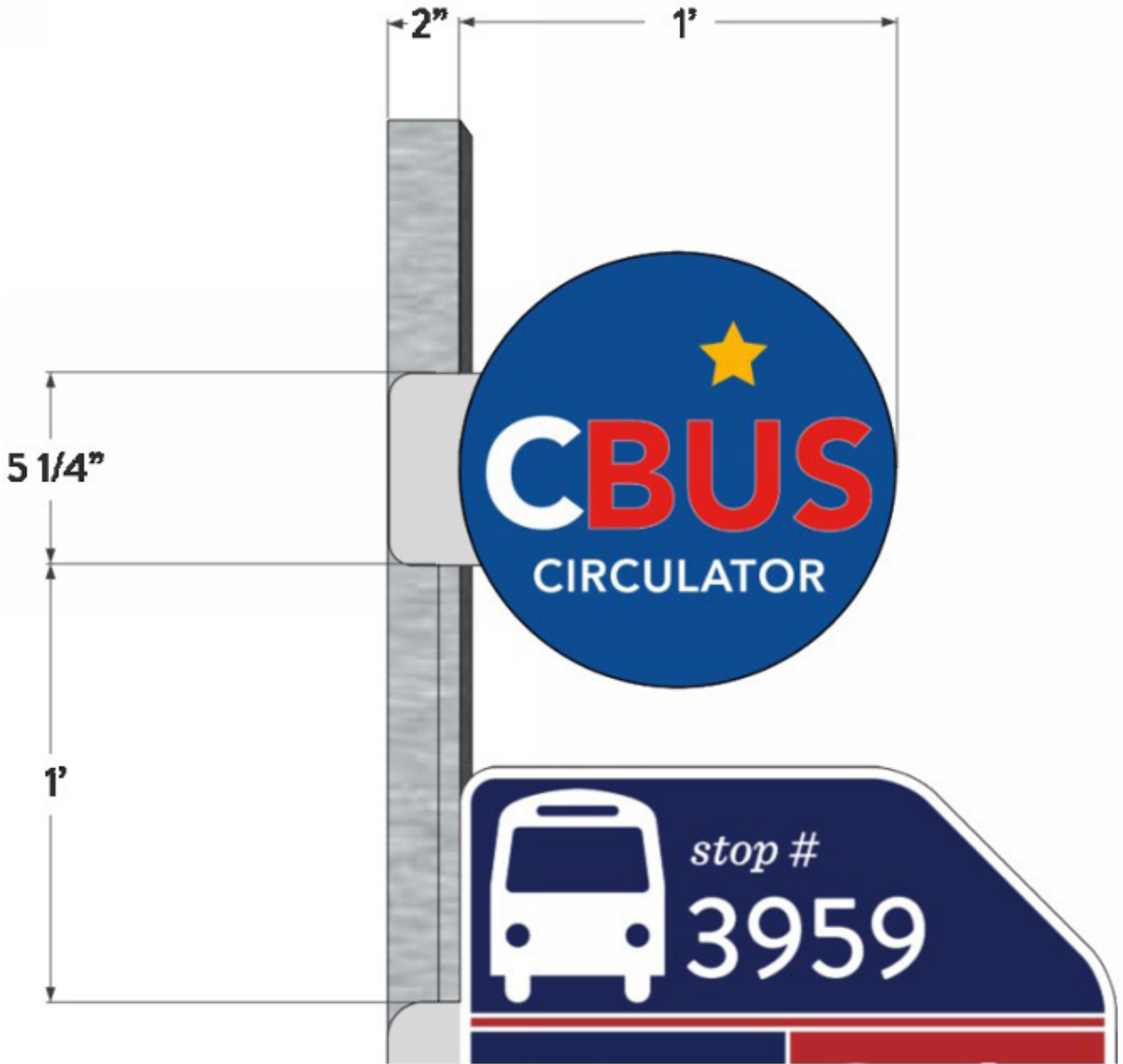
<Common Drive>\Capital Projects and Planning\Short Range Transit Plan\2011-2015 Short Range Transit Plan\Figures\Service\_Area



Transit Sign Dimensions

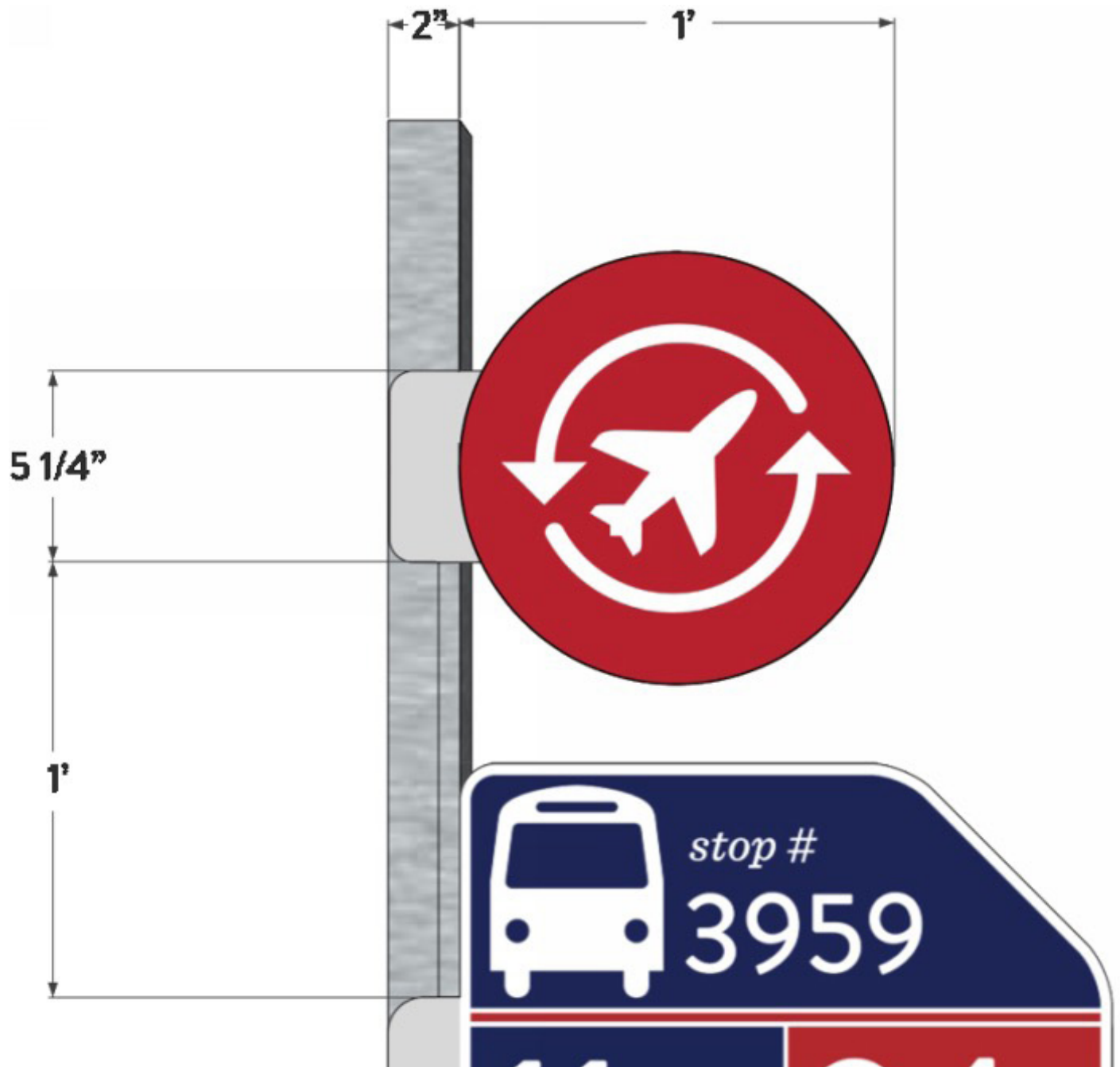


CBUS Circulator Sign Dimensions

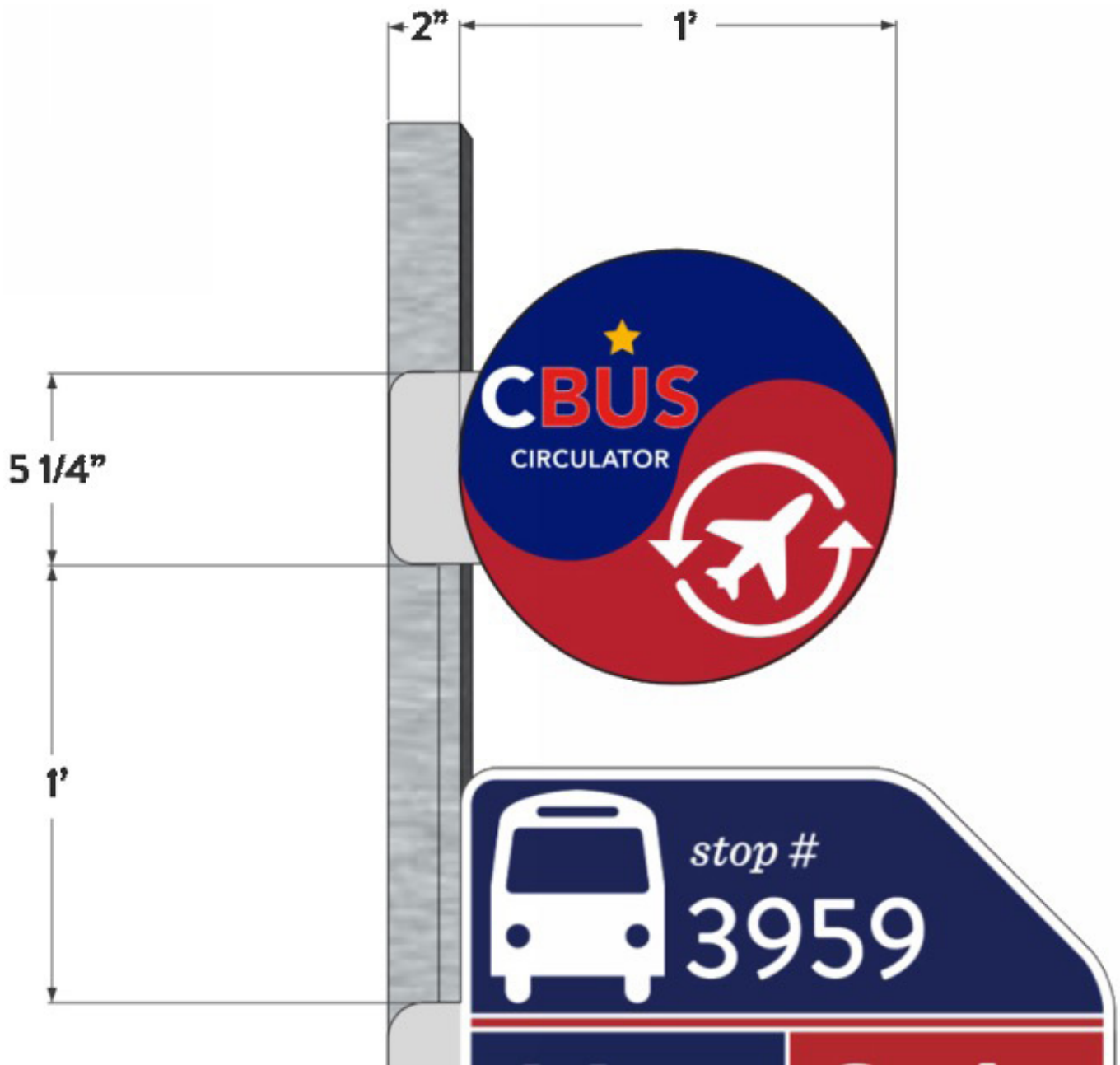




AirConnect Sign Dimensions

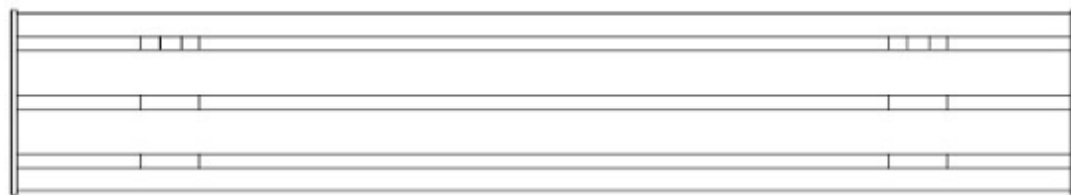


## CBUS Circulator/AirConnect Sign Dimensions

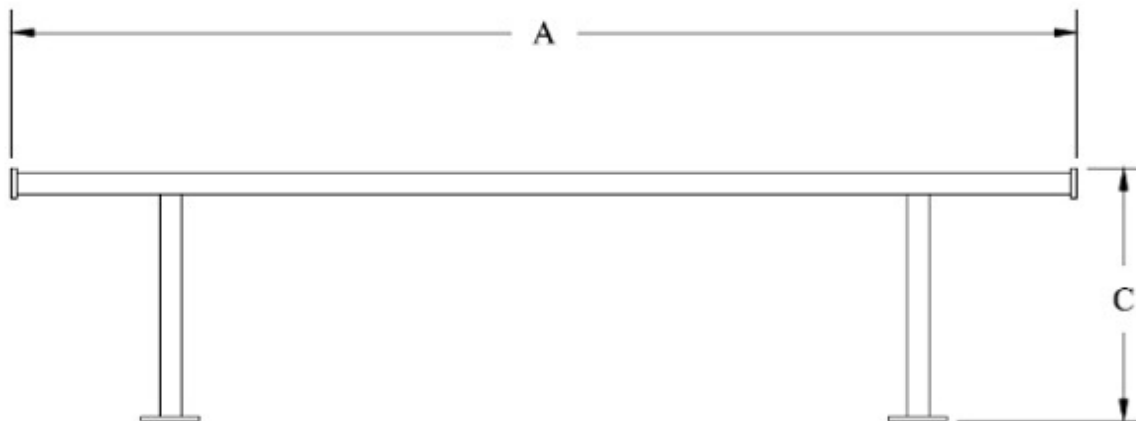


## COTA Freestanding Bench

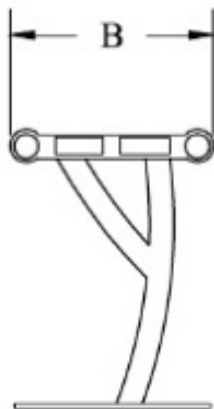
Information from [keystoneridgedesigns.com](http://keystoneridgedesigns.com)



**LENGTH (A)**  
**WIDTH (B)**  
**HEIGHT (C)**  
**SEAT HEIGHT**  
**WEIGHT**



PN14	PN16	PN18
4ft	6ft	8ft
48"	72"	94"
12 1/2"	12 1/2"	12 1/2"
17 1/8"	17 1/8"	17 1/8"
17 1/8"	17 1/8"	17 1/8"
125 lbs.	150 lbs.	165 lbs.



**Simme Seat**

Information from [simmeseat.com](http://simmeseat.com)



## SIMME-SEAT INSTALLATION INSTRUCTIONS

**PLAN**

**SIDE ELEVATION**

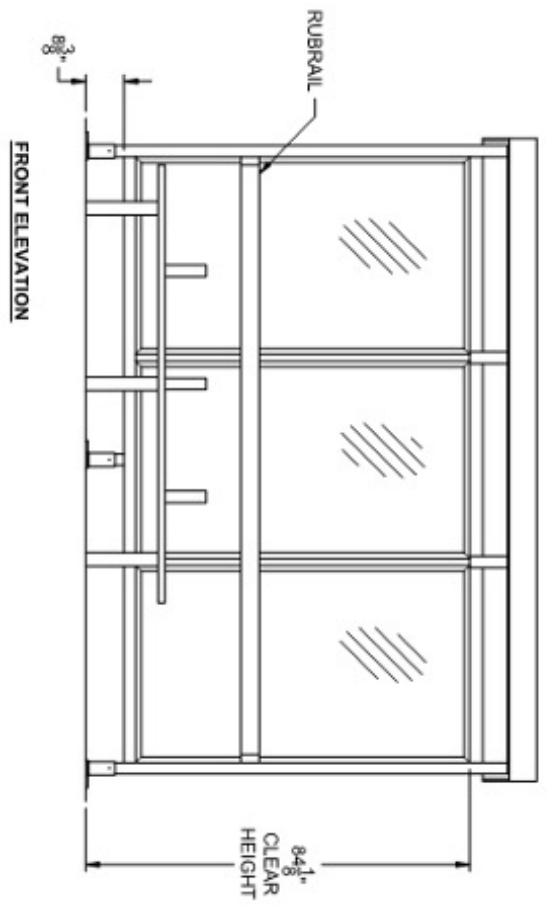
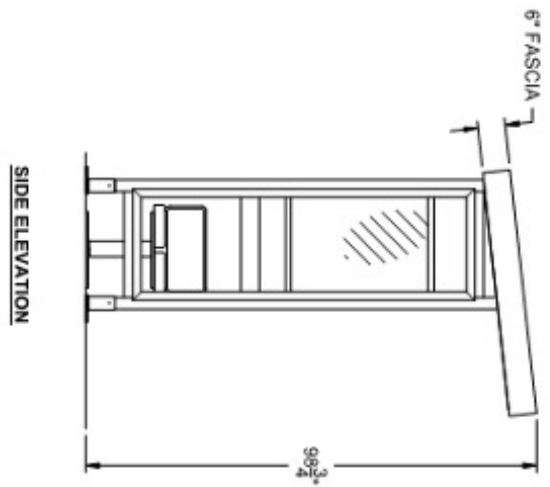
**FRONT ELEVATION**

**NOTE:** WHEN INSTALLED ACCORDING TO THESE INSTRUCTIONS, THIS STRUCTURE WILL WITHSTAND THE WIND FORCES CREATED BY A MAXIMUM WIND CATEGORY I WIND VELOCITY - UP TO 182 MPH (COVERS ALL SOUTH FLORIDA EQUIVALENT TO 175 MPH WIND CAT 2)

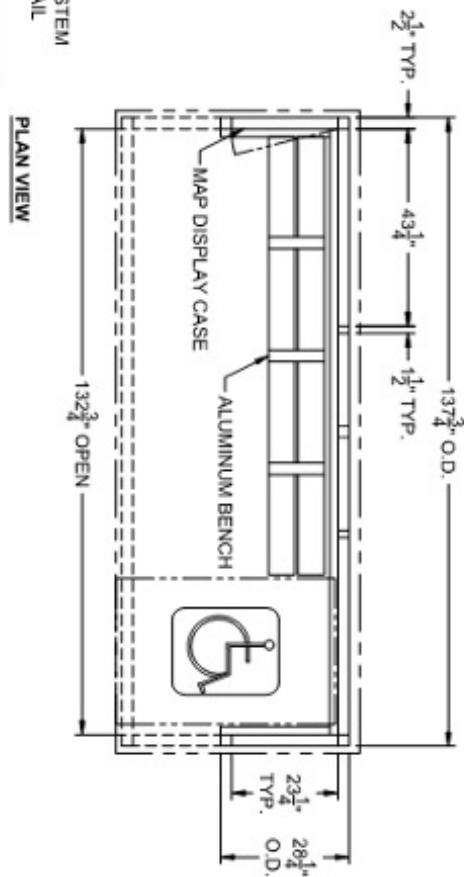
WIND CAT. - 12 MPH (1.9 SF) SIGN @ 10'0" CENTERLINE MAX.  
 UP TO 30' CAT. C - 15 MPH (3.9 SF) SIGN @ 5.8' CENTERLINE MAX.

**INSTALLATION ON EXISTING CONCRETE**

Simme L.L.C. 555 Cherry Drive Eugene, OR 97401 TEL: (847) 555-7885 E-MAIL: SIMME-SEAT@COWI.COM		DATE: 2/21/2019 FILE NO: SS-1/19
DESIGNED BY: JG	APP. BY: CS	PLT. SCALE: 1/4" = 1'-0"
DWG. NO.:		SS-1



- QUANTITY (15) SHELTERS THUS**
- SPECIFICATIONS:**
- POWDER COATED ALUMINUM STRUCTURE - RAL 9006 WHITE ALUMINUM
  - 3/8" CLEAR LAMINATED SAFETY GLASS
  - CLEAR STRUCTURED POLYCARBONATE GLAZED ROOF WITH FASCIA/GUTTER SYSTEM
  - PARTIAL LENGTH ALUMINUM BENCH WITH ANTI-VAGRANT ARMRESTS AND RUBRAIL
  - MAP DISPLAY CASE WITH 20" X 30" VIEWABLE AREA



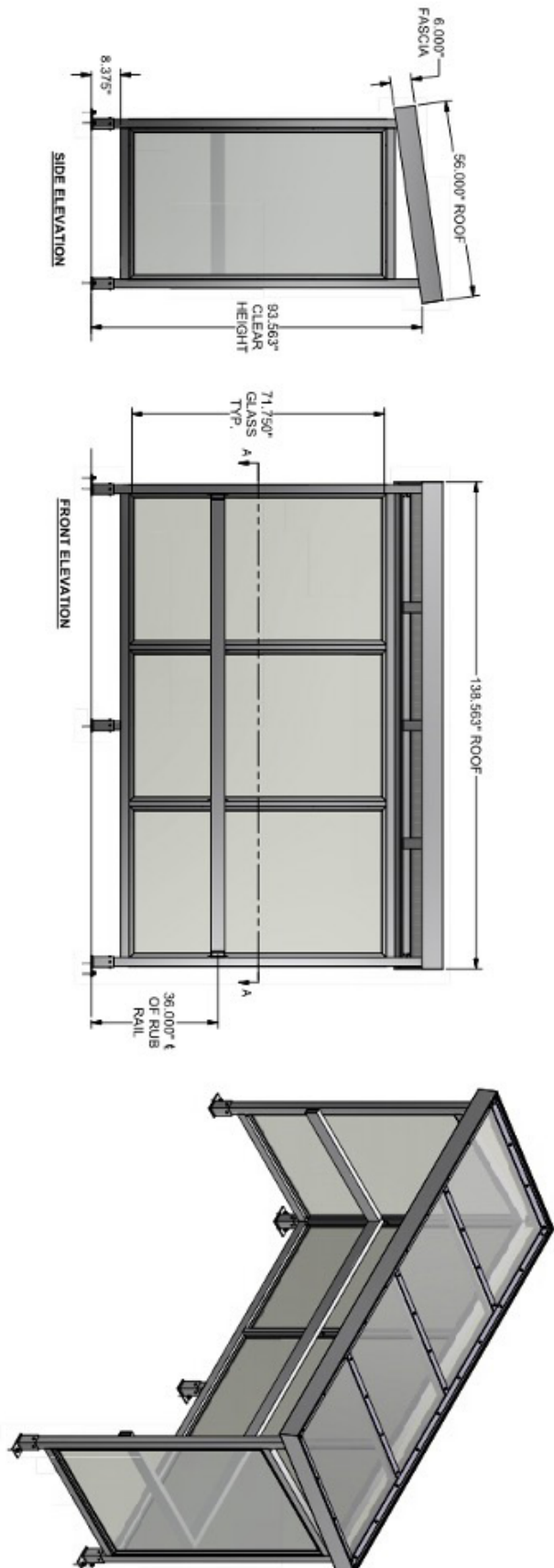
**BRASCO INTERNATIONAL, INC.**  
 32400 INDUSTRIAL DRIVE  
 MADISON HEIGHTS, MICHIGAN 48071  
 1-800-893-3665 WWW.BRASCO.COM

THIS DRAWING IS CONFIDENTIAL AND IS FOR THE SOLE USE OF OUR CUSTOMERS AND MAY NOT BE REPRODUCED OR COPIED WITHOUT WRITTEN PERMISSION FROM BRASCO INTERNATIONAL. LEAD TIME BEGINS UPON RECEIPT OF SIGNED APPROVAL.

SIGNED: \_\_\_\_\_ DATE: \_\_\_\_\_

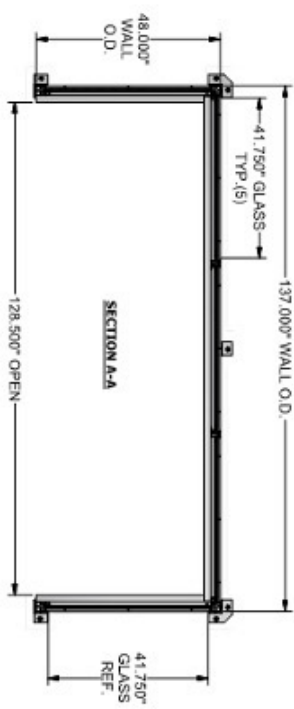
CUSTOMER:	COTA	ENGINEER:	HAUS
PROJECT:	GLAZED SHED STYLE TRANSIT SHELTER	DATE:	1-27-14
MODEL:	SLIMLINE SERIES - SL12-C	CHECKER:	BDH
JOB #	3674	DATE:	1-28-14
SHEET #:	3674-S1		

**COTA 4'x12' Shelter**



**QUANTITY (XX) SHELTERS THUS**

- SPECIFICATIONS:**
- RAL 9006 WHITE ALUMINUM POWDER COATED ALUMINUM STRUCTURE
  - 3/8" CLEAR LAMINATED SAFETY GLASS (ASSEMBLES SHIPPED LOOSE)
  - 1 3/4" x 4" ALUMINUM RUB RAIL (FULL INSIDE PERIMETER)
  - 10mm WHITE STRUCTURED POLYCARBONATE SLOPED ROOF WITH 6" FASCIA



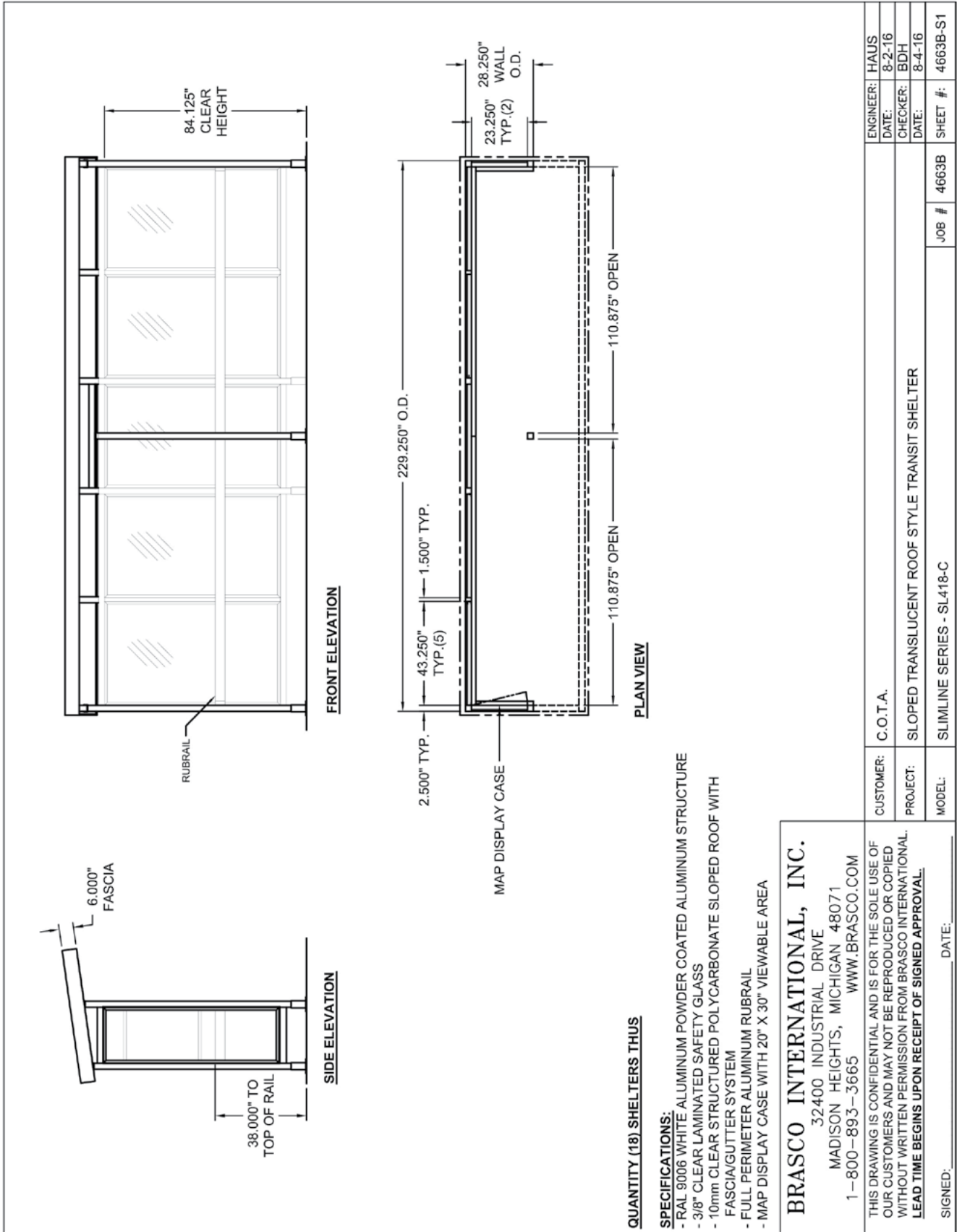

BRASCO INTERNATIONAL, INC.  
 37400 INDUSTRIAL DR. 48071  
 HUDSON HEIGHTS, MI 48134  
 1-800-850-3693 WWW.BRASCO.COM

THIS DRAWING IS CONFIDENTIAL AND IS FOR THE SOLE USE OF OUR CUSTOMERS AND MAY NOT BE REPRODUCED OR COPIED WITHOUT WRITTEN PERMISSION FROM BRASCO INTERNATIONAL.

**THIS DRAWING IS CONFIDENTIAL AND IS FOR THE SOLE USE OF OUR CUSTOMERS AND MAY NOT BE REPRODUCED OR COPIED WITHOUT WRITTEN PERMISSION FROM BRASCO INTERNATIONAL. LEAD TIME BEGINS UPON RECEIPT OF SIGNED APPROVAL.**

SIGNED: \_\_\_\_\_ DATE: \_\_\_\_\_

CUSTOMER	PROJECT	DATE	REVISION
C O T A	CUSTOM SIMLINE SHELTER	7-21-19	8-1-19
MODEL	CSL-04-12-OF-130L-SL-PTC-10	SHEET 001	REVISION A



**QUANTITY (18) SHELTERS THUS**

- SPECIFICATIONS:**
- RAL 9006 WHITE ALUMINUM POWDER COATED ALUMINUM STRUCTURE
  - 3/8" CLEAR LAMINATED SAFETY GLASS
  - 10mm CLEAR STRUCTURED POLYCARBONATE SLOPED ROOF WITH FASCIA/GUTTER SYSTEM
  - FULL PERIMETER ALUMINUM RUBRAIL
  - MAP DISPLAY CASE WITH 20" X 30" VIEWABLE AREA

**BRASCO INTERNATIONAL, INC.**  
 32400 INDUSTRIAL DRIVE  
 MADISON HEIGHTS, MICHIGAN 48071  
 1-800-893-3665 WWW.BRASCO.COM

THIS DRAWING IS CONFIDENTIAL AND IS FOR THE SOLE USE OF OUR CUSTOMERS AND MAY NOT BE REPRODUCED OR COPIED WITHOUT WRITTEN PERMISSION FROM BRASCO INTERNATIONAL. LEAD TIME BEGINS UPON RECEIPT OF SIGNED APPROVAL.

SIGNED: \_\_\_\_\_ DATE: \_\_\_\_\_

CUSTOMER: C.O.T.A.

PROJECT: SLOPED TRANSLUCENT ROOF STYLE TRANSIT SHELTER

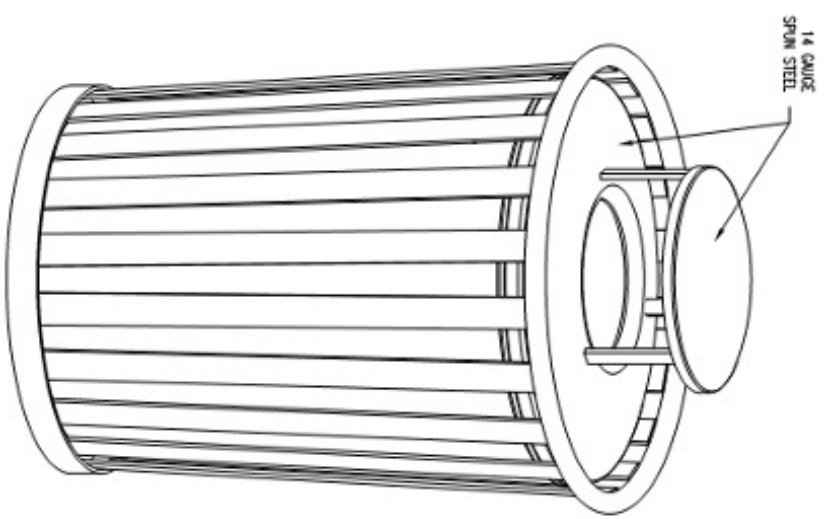
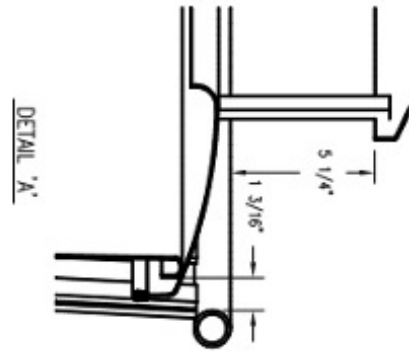
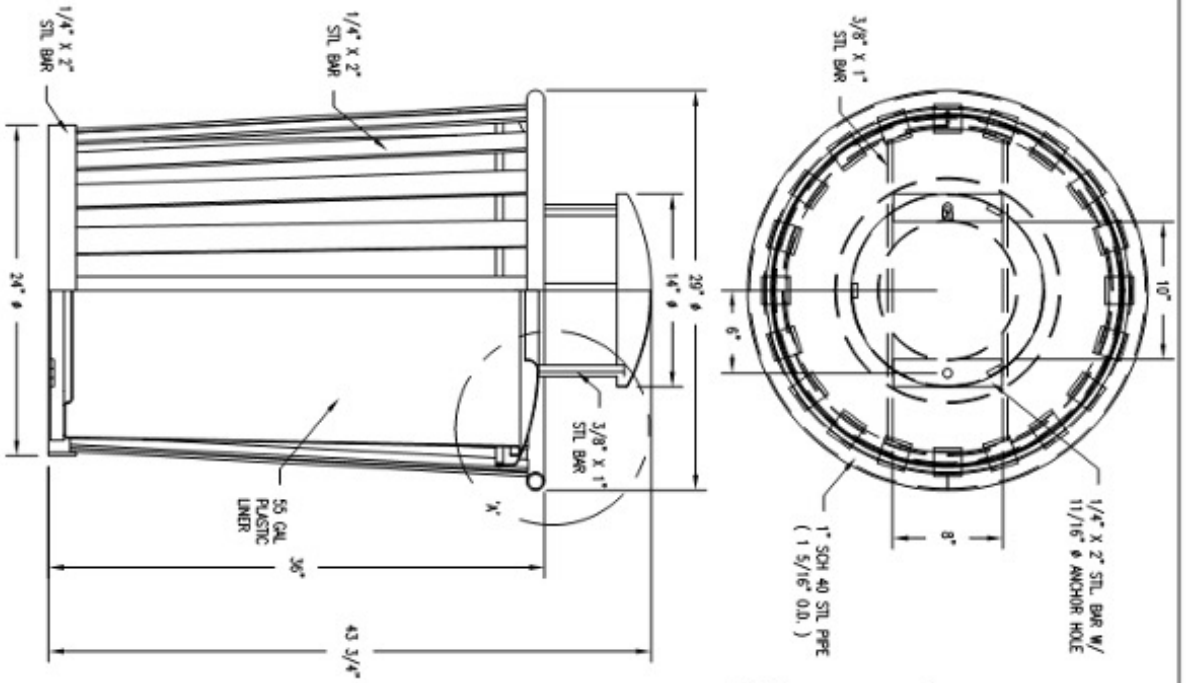
MODEL: SLIMLINE SERIES - SL418-C

JOB # 4663B

SHEET #: 4663B-S1

ENGINEER: HAUS  
 DATE: 8-2-16  
 CHECKER: BDH  
 DATE: 8-4-16

COTA Trash Receptacle



- NOTES:
- 1.) ALL STL MEMBERS COATED W/ ZINC RICH EPOXY THEN FINISHED W/ POLYESTER POWDER COATING.
  - 2.) 1/2" X 3 3/4" EXPANSION ANCHOR BOLTS PROVIDED.
  - 3.) ALL WELDS CONT. THEN GROUND SMOOTH.
  - 4.) RECEPTACLE FULLY ASSEMBLED AT FACTORY.

APPROVED \_\_\_\_\_ DATE : \_\_\_\_\_

**DUMOR, inc.**  
 P.O. Box 142 Milltown, PA 17059-0142

DATE DRAWN : 3/31/08	TITLE	REVISION	DRAWING NUMBER
DRAWN BY : AMH	RECEPTACLE	C	66-937-55-BT SH1
DATE REV. : 10/06/10			
REV. BY : ESS			



# TRANSIT GUIDE RESOURCES

1. NACTO Transit Street Design Guide: Transit Route Types ([Link](#))
2. Ohio Department of Transportation Construction & Material Specifications ([Link](#))
3. Franklin County Engineers Pavement Design Standards ([Link](#))
4. City of Columbus Downtown Streetscape Standards ([Link](#))
5. City of Columbus Standard Drawings ([Link](#))
6. City of Dublin Standard Drawings ([Link](#))
7. City of Upper Arlington Engineering Division ([Link](#))
8. City of Grove City Standard Drawings ([Link](#))
9. City of Hilliard Standard Drawings ([Link](#))
10. City of Groveport Standard Drawings ([Link](#))
11. City of Bexley Building & Zoning Department ([Link](#))
12. City of Whitehall Building Department ([Link](#))
13. City of Worthington Service & Engineering Division ([Link](#))
14. Village of Obetz Engineering Division ([Link](#))
15. City of Canal Winchester Roadway Standard Drawings ([Link](#))
16. City of Gahanna Public Service & Engineering ([Link](#))
17. City of Westerville Standard Drawings ([Link](#))
18. City of Reynoldsburg Standard Drawings ([Link](#))